

# DATA SHEET

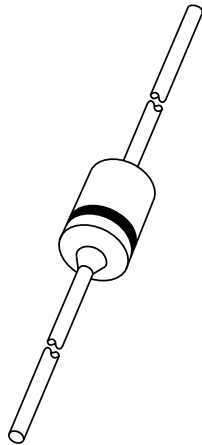

## **BYD43 series** **Fast soft-recovery rectifiers**

Product specification  
Supersedes data of February 1995  
File under Discrete Semiconductors, SC01

1996 Jun 05

## Fast soft-recovery rectifiers

## BYD43 series

## FEATURES

- Glass passivated
- High maximum operating temperature
- Low leakage current
- Excellent stability
- Available in ammo-pack.

## DESCRIPTION

Cavity free cylindrical glass package through Implotec™<sup>(1)</sup> technology. This package is hermetically sealed

and fatigue free as coefficients of expansion of all used parts are matched.

(1) Implotec is a trademark of Philips.

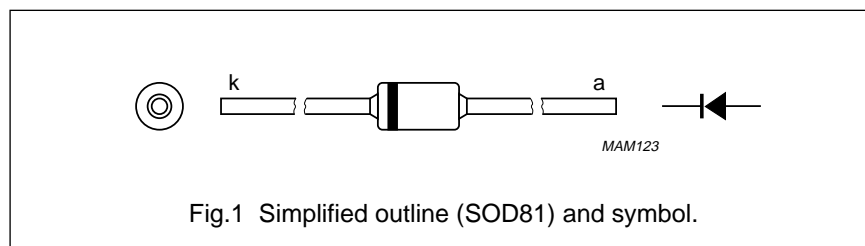

## LIMITING VALUES

In accordance with the Absolute Maximum Rating System (IEC 134).

SYMBOL	PARAMETER	CONDITIONS	MIN.	MAX.	UNIT
$V_{RSM}$	non-repetitive peak reverse voltage				
	BYD43U		–	1300	V
	BYD43V		–	1500	V
	BYD43-16		–	1700	V
	BYD43-18		–	1900	V
	BYD43-20		–	2100	V
$V_{RRM}$	repetitive peak reverse voltage				
	BYD43U		–	1200	V
	BYD43V		–	1400	V
	BYD43-16		–	1600	V
	BYD43-18		–	1800	V
	BYD43-20		–	2000	V
$I_{F(AV)}$	average forward current	$T_{tp} = 55\text{ °C}$ ; lead length = 10 mm; see Figs 2 and 3;			
	BYD43U and V	averaged over any 20 ms period; see also Figs 10 and 11	–	1.20	A
	BYD43-16 to 20		–	0.68	A
$I_{F(AV)}$	average forward current	$T_{amb} = 65\text{ °C}$ ; PCB mounting (see Fig.20); see Figs 4 and 5;			
	BYD43U and V	averaged over any 20 ms period; see also Figs 10 and 11	–	0.65	A
	BYD43-16 to 20		–	0.30	A
$I_{FRM}$	repetitive peak forward current	$T_{tp} = 55\text{ °C}$ ; see Figs 6 and 7			
	BYD43U and V		–	11	A
	BYD43-16 to 20		–	6	A
$I_{FRM}$	repetitive peak forward current	$T_{amb} = 65\text{ °C}$ ; see Figs 8 and 9			
	BYD43U and V		–	6.0	A
	BYD43-16 to 20		–	3.2	A

## Fast soft-recovery rectifiers

## BYD43 series

SYMBOL	PARAMETER	CONDITIONS	MIN.	MAX.	UNIT
$I_{FSM}$	non-repetitive peak forward current	$t = 10$ ms half sinewave; $T_j = T_{j\ max}$ prior to surge; $V_R = V_{RRM\ max}$	–	6	A
	BYD43U and V BYD43-16 to 20		–	6	A
$T_{stg}$	storage temperature		–65	+175	°C
$T_j$	junction temperature	see Figs 12 and 13	–65	+175	°C

## ELECTRICAL CHARACTERISTICS

$T_j = 25$  °C unless otherwise specified.

SYMBOL	PARAMETER	CONDITIONS	MIN.	TYP.	MAX.	UNIT
$V_F$	forward voltage BYD43U and V BYD43-16 to 20	$I_F = 1$ A; $T_j = T_{j\ max}$ ; see Figs 14 and 15	–	–	1.20	V
			–	–	2.05	V
$V_F$	forward voltage BYD43U and V BYD43-16 to 20	$I_F = 1$ A; see Figs 14 and 15	–	–	1.5	V
			–	–	2.4	V
$I_R$	reverse current BYD43U and V BYD43-16 to 20	$V_R = V_{RRM\ max}$ ; see Figs 16 and 17	–	–	1	µA
			–	–	5	µA
$I_R$	reverse current BYD43U and V BYD43-16 to 20	$V_R = V_{RRM\ max}$ $T_j = 165$ °C; see Fig 16 $T_j = 125$ °C; see Fig 17	–	–	100	µA
			–	–	50	µA
$t_{rr}$	reverse recovery time BYD43U and V BYD43-16 to 20	when switched from $I_F = 0.5$ A to $I_R = 1$ A; measured at $I_R = 0.25$ A; see Fig 22	–	–	250	ns
			–	–	300	ns
$C_d$	diode capacitance BYD43U and V BYD43-16 to 20	$f = 1$ MHz; $V_R = 0$ V; see Figs 18 and 19	–	20	–	pF
			–	15	–	pF
$\left  \frac{dI_R}{dt} \right $	maximum slope of reverse recovery current BYD43U and V BYD43-16 to 20	when switched from $I_F = 1$ A to $V_R \geq 30$ V and $dI_F/dt = -1$ A/µs; see Fig.21	–	–	5	A/µs
			–	–	5	A/µs

## THERMAL CHARACTERISTICS

SYMBOL	PARAMETER	CONDITIONS	VALUE	UNIT
$R_{th\ j-tp}$	thermal resistance from junction to tie-point	lead length = 10 mm	60	K/W
$R_{th\ j-a}$	thermal resistance from junction to ambient	note 1	120	K/W

## Note

1. Device mounted on an epoxy-glass printed-circuit board, 1.5 mm thick; thickness of Cu-layer  $\geq 40$  µm, see Fig.20. For more information please refer to the 'General Part of Handbook SC01'.

Fast soft-recovery rectifiers

BYD43 series

GRAPHICAL DATA

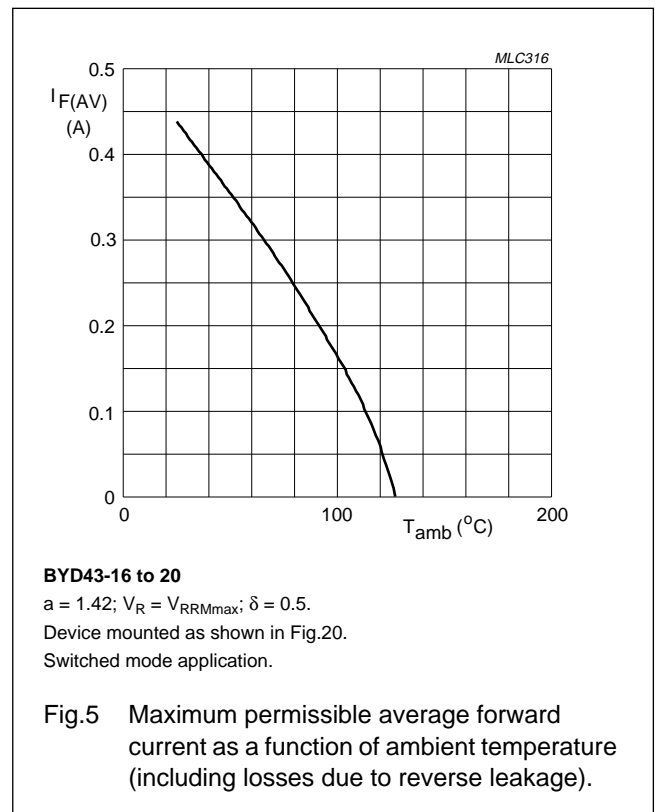
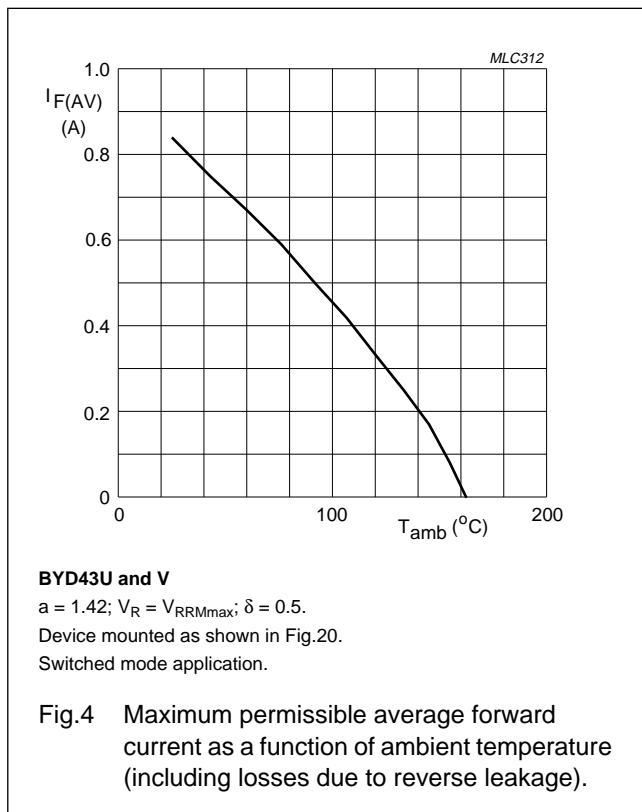
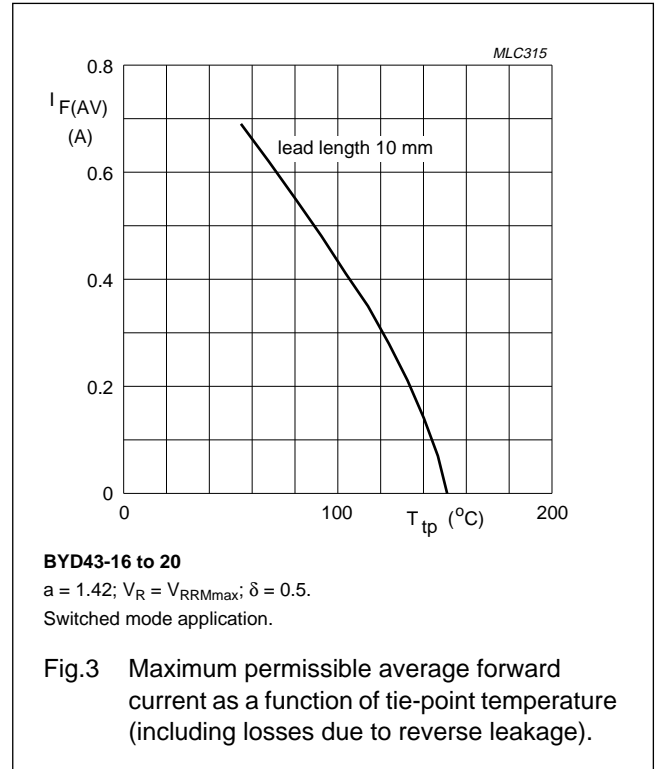
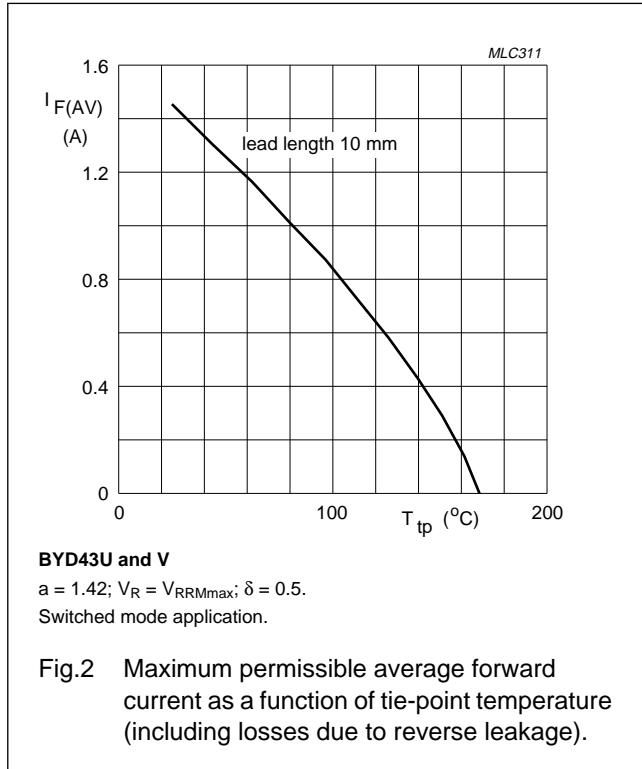

Fast soft-recovery rectifiers

BYD43 series

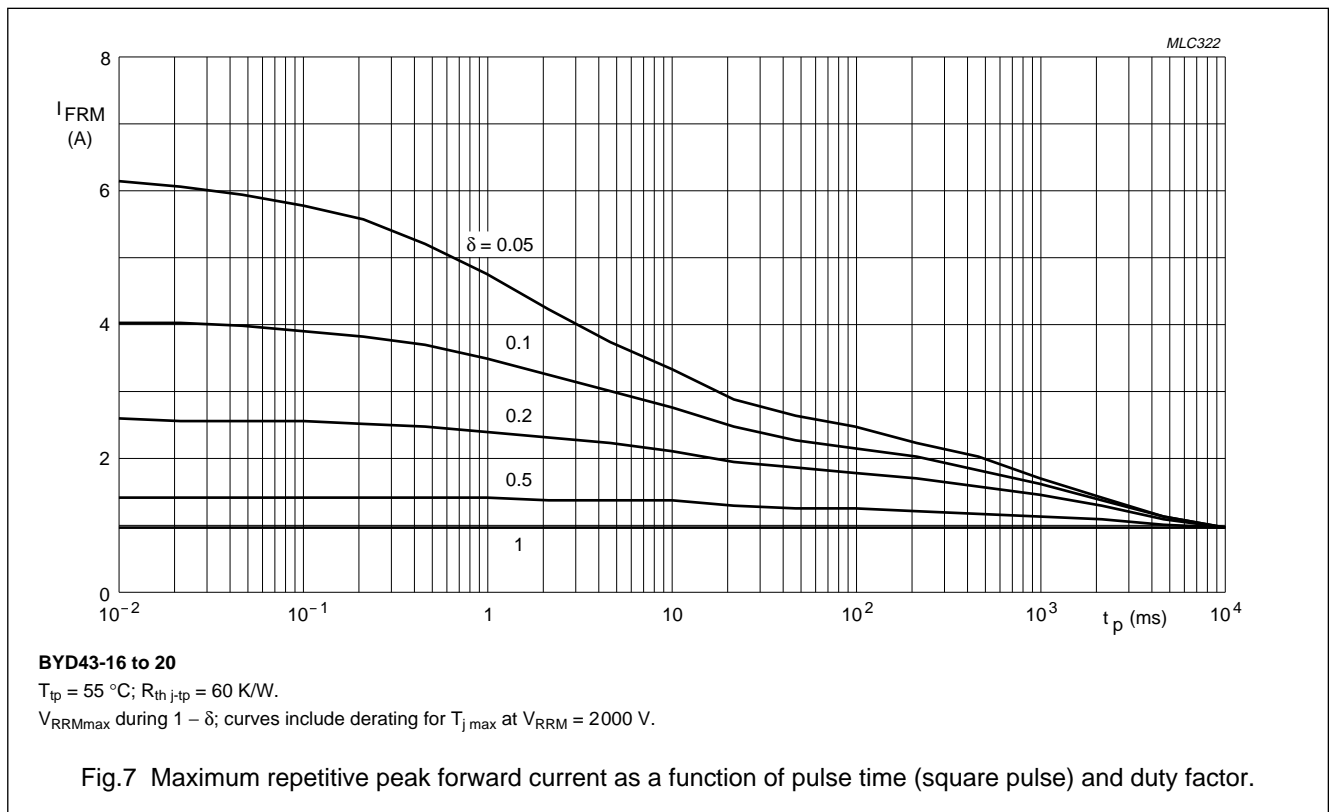
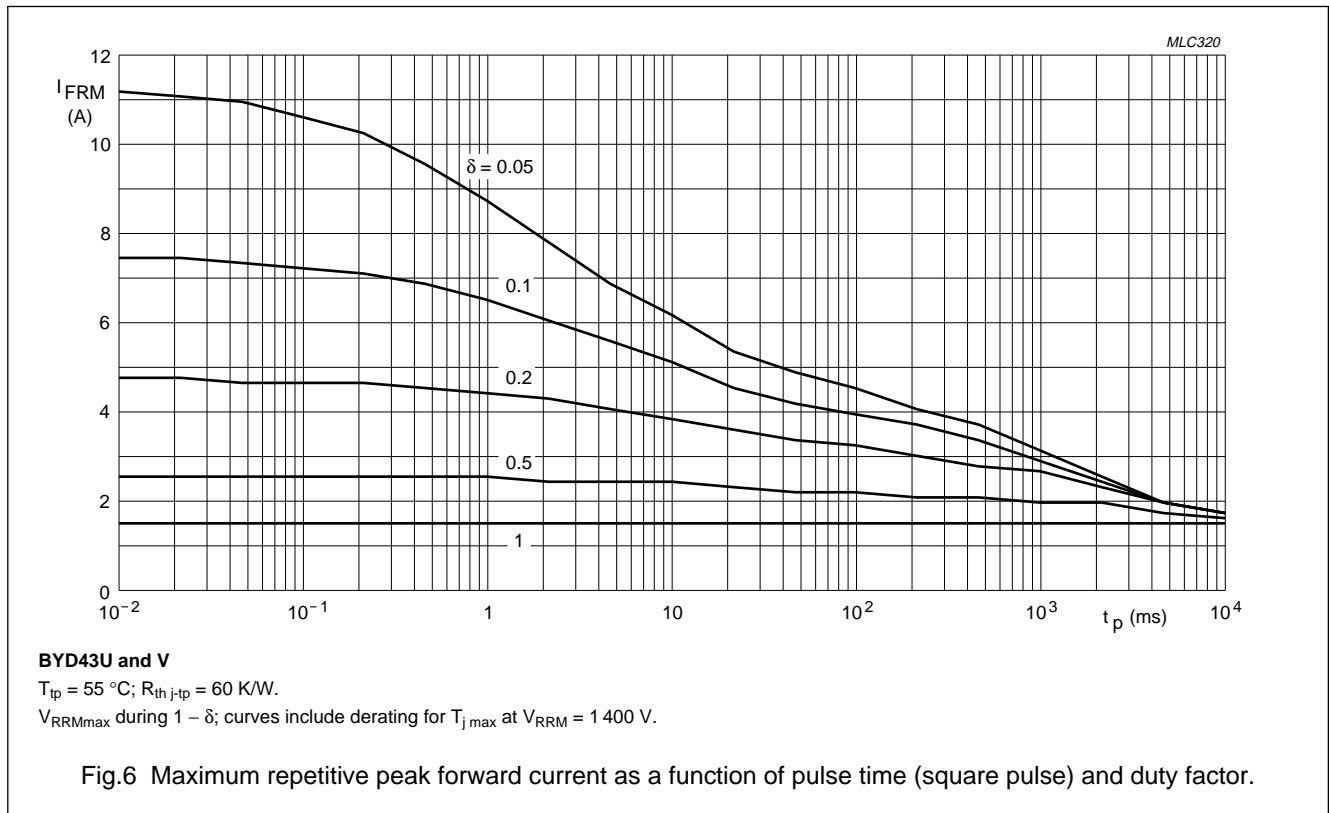

Fast soft-recovery rectifiers

BYD43 series

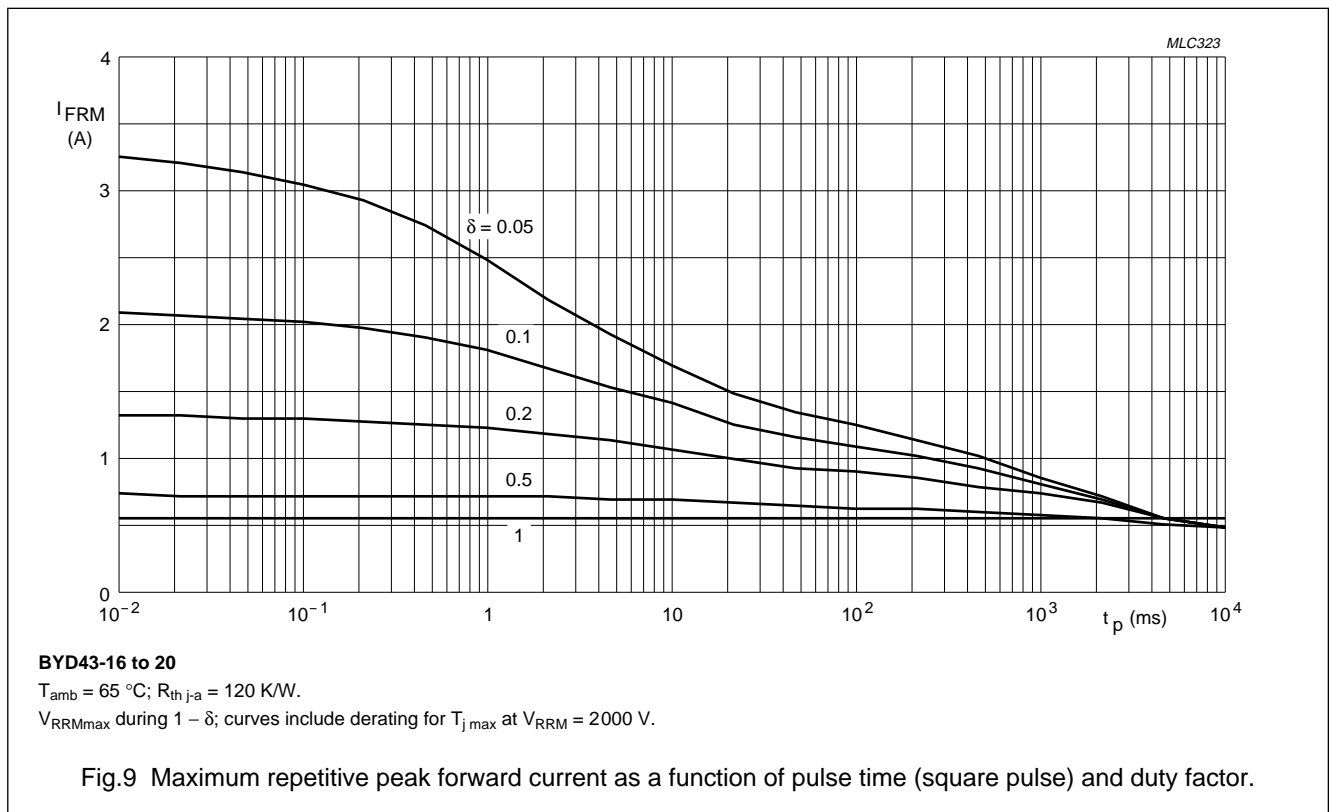
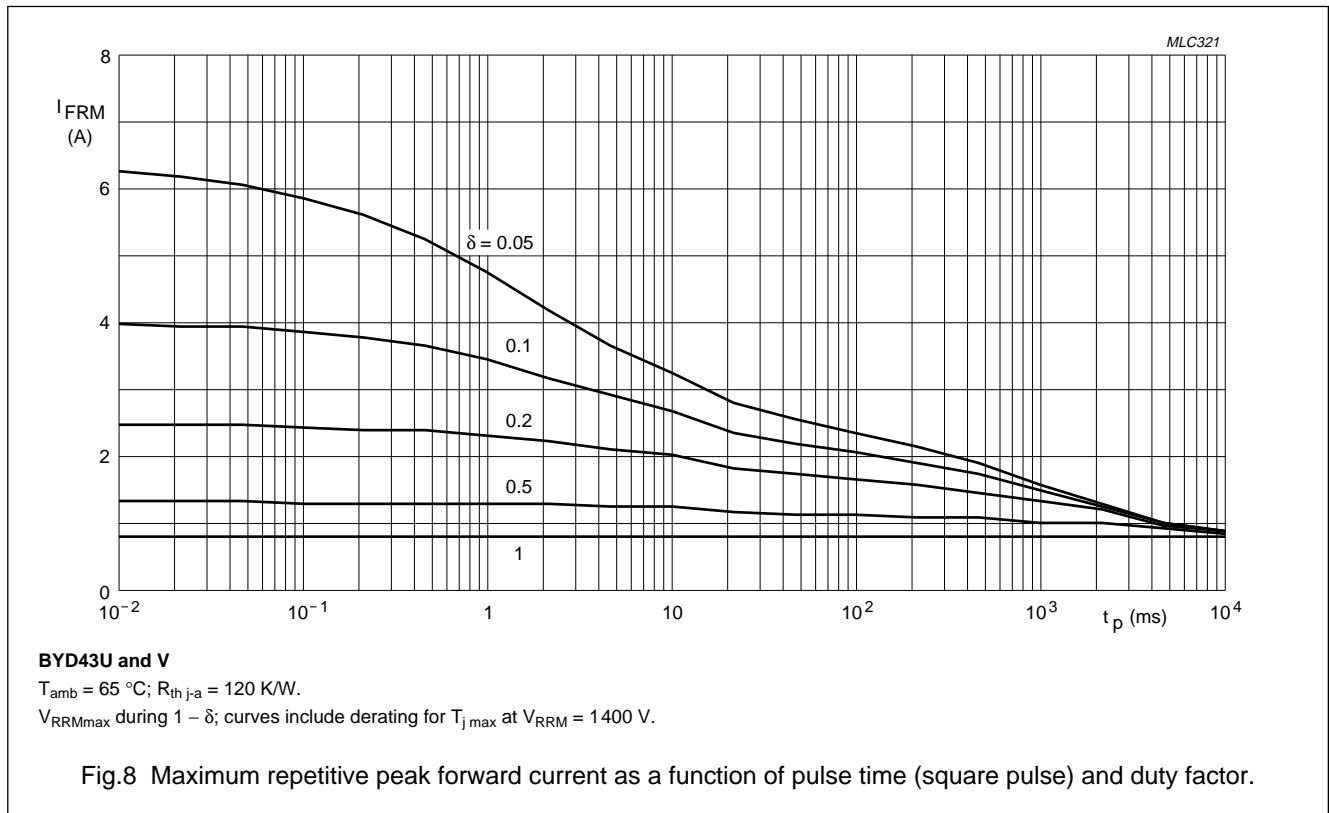

Fast soft-recovery rectifiers

BYD43 series

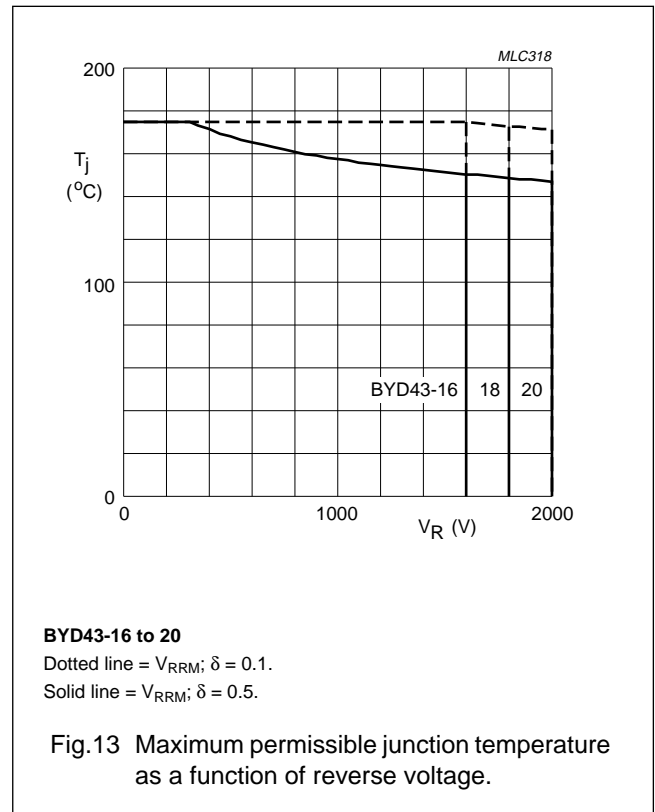
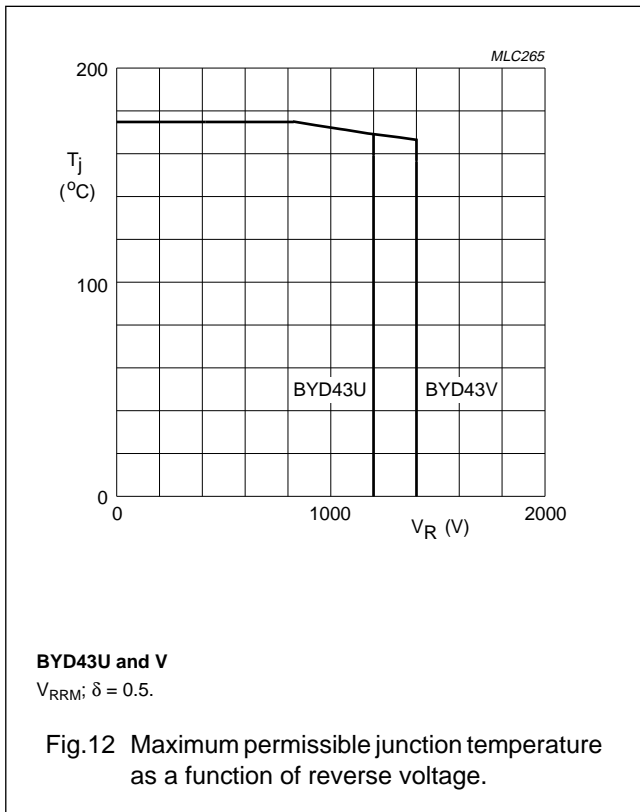
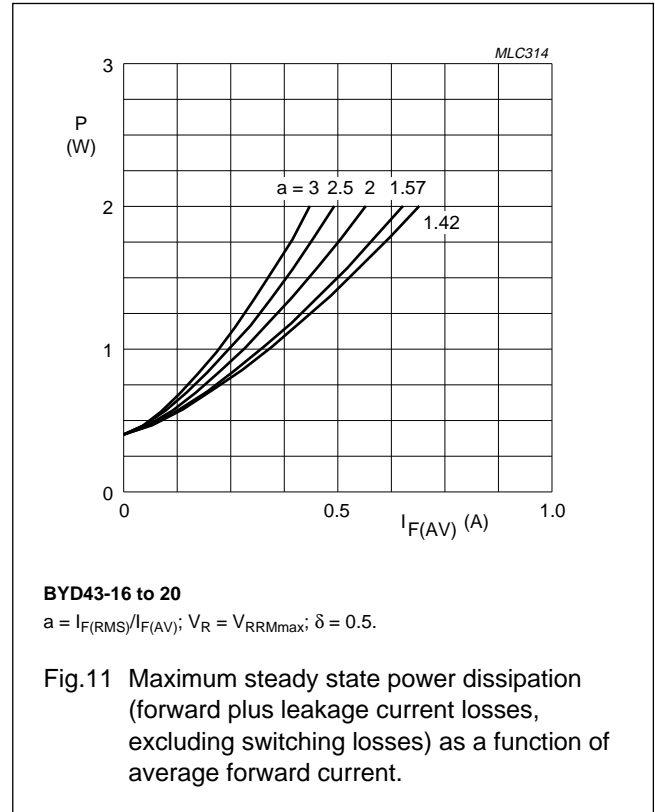
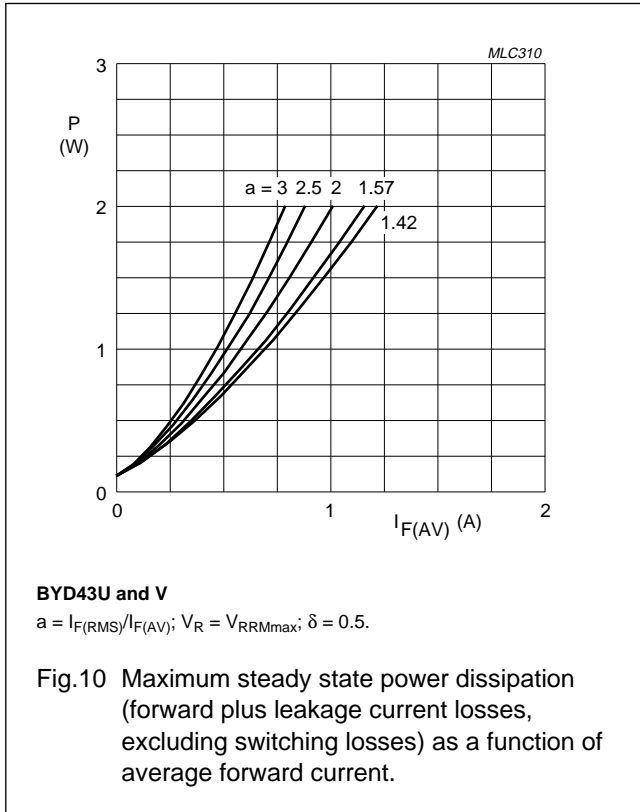

Fast soft-recovery rectifiers

BYD43 series

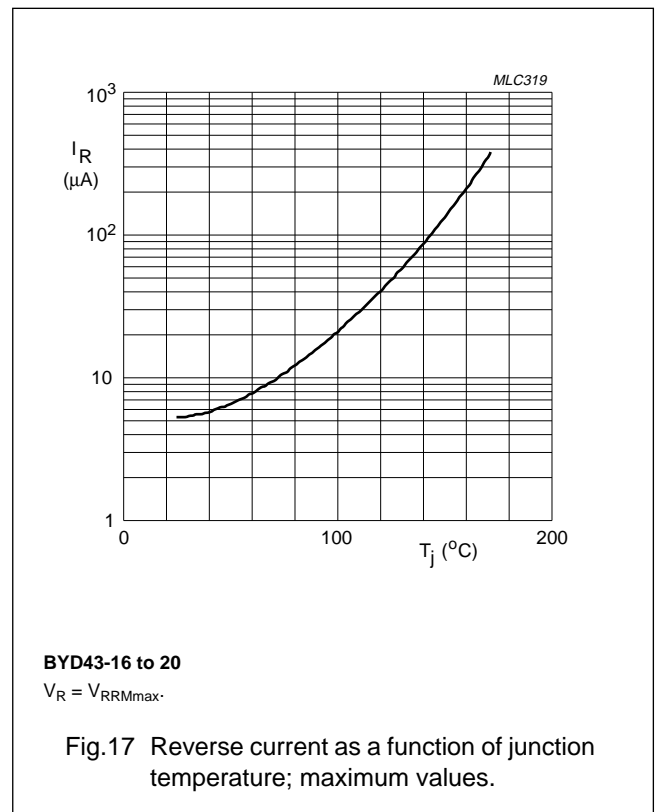
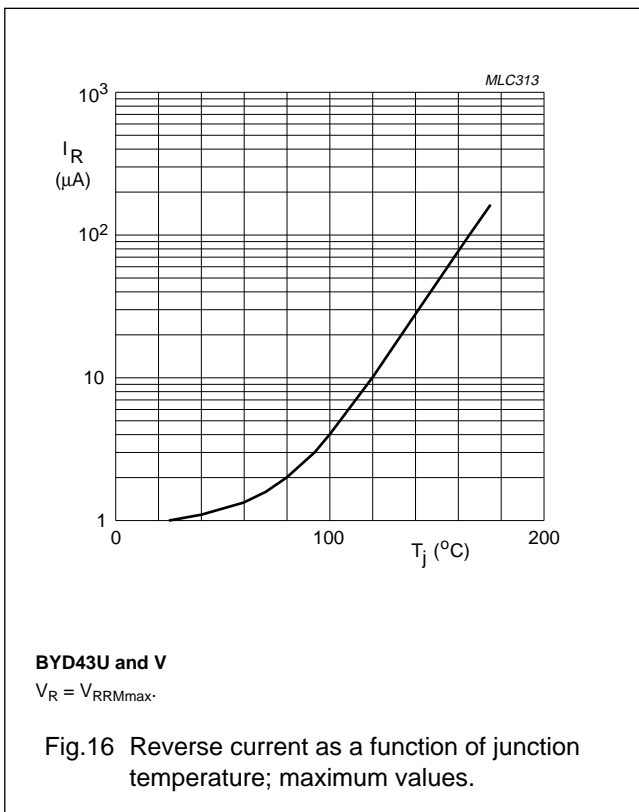
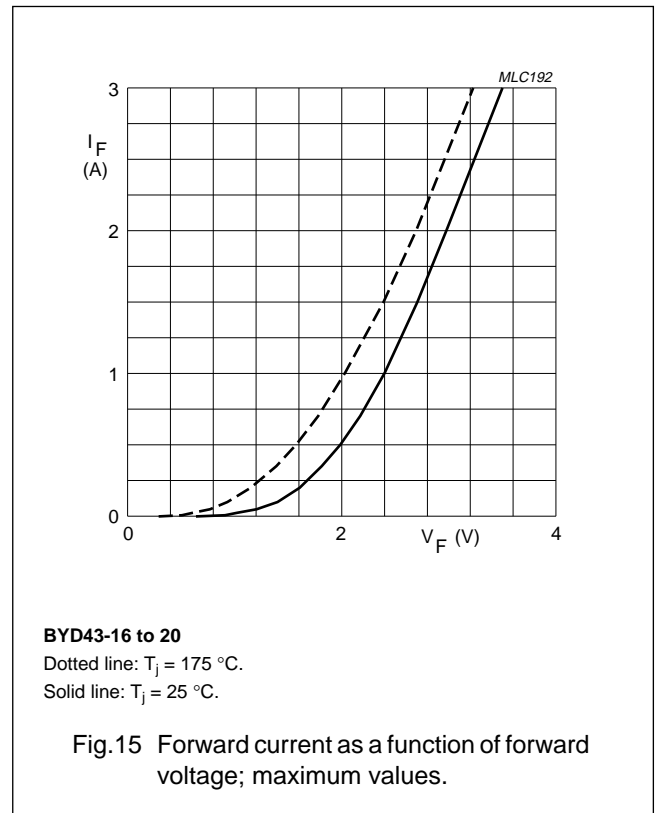
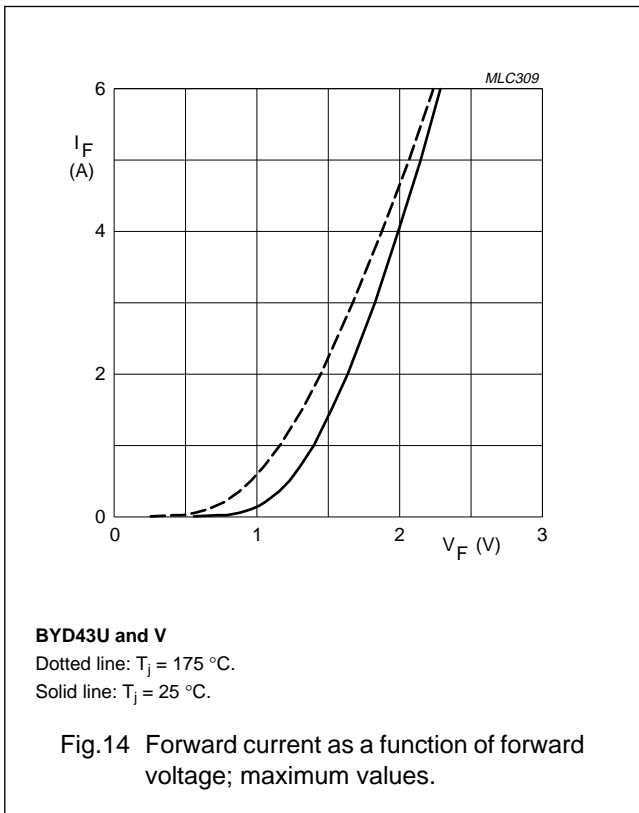



Fast soft-recovery rectifiers

BYD43 series

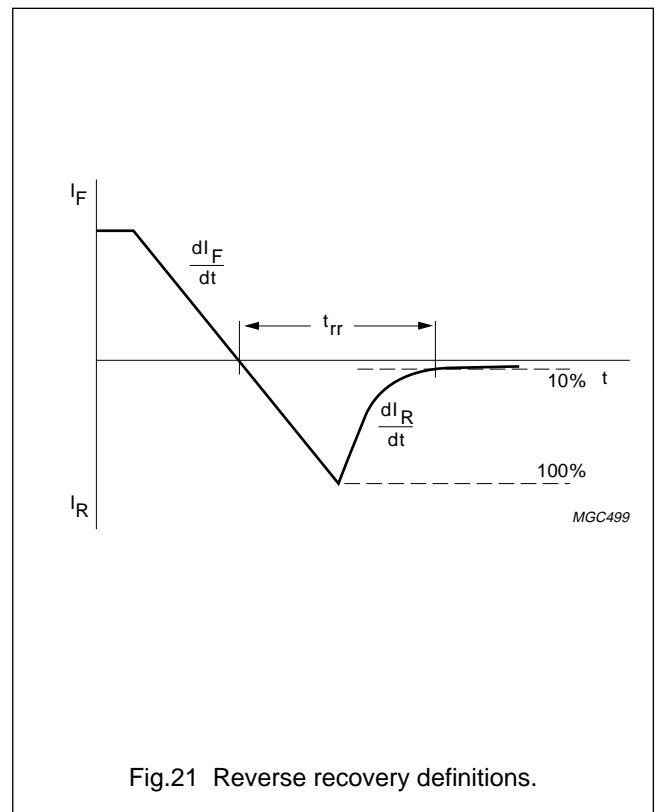
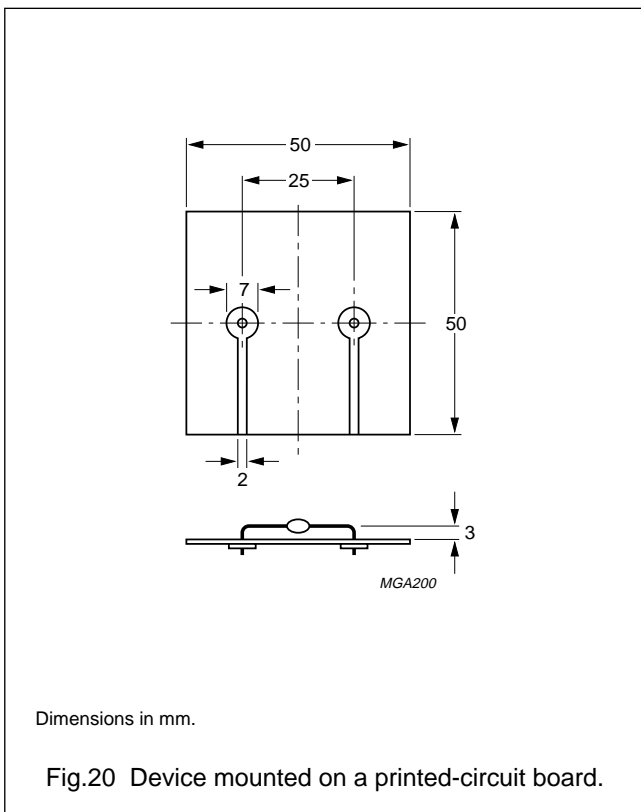
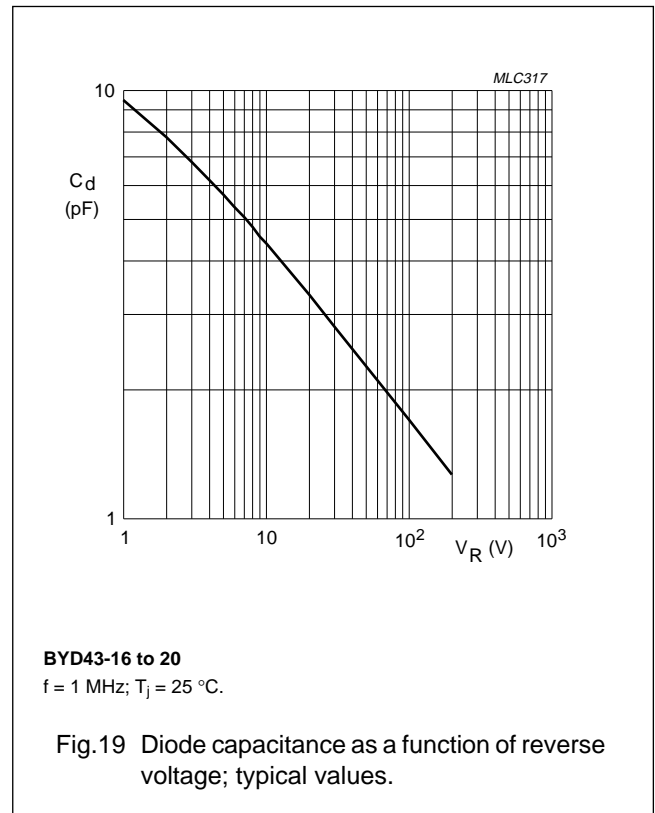
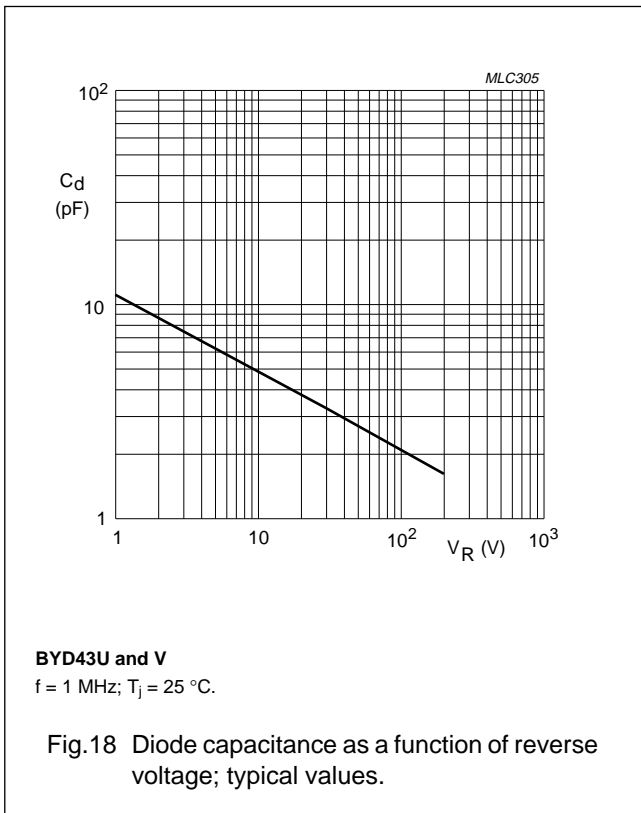

Fast soft-recovery rectifiers

BYD43 series

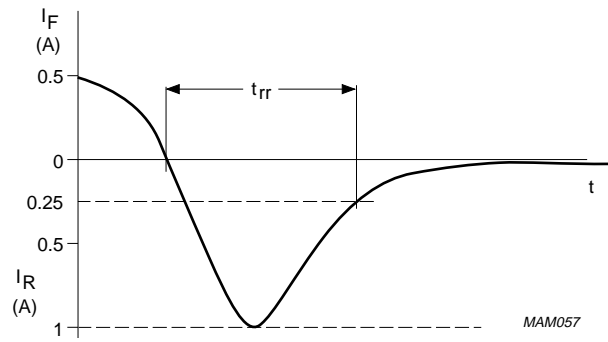
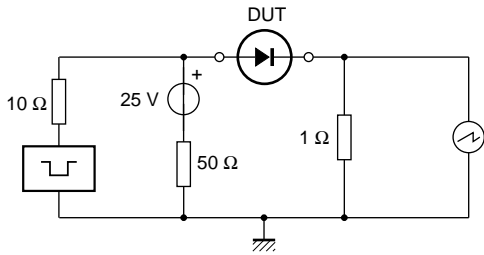

Input impedance oscilloscope: 1 MΩ, 22 pF;  $t_r \leq 7$  ns.  
Source impedance: 50 Ω;  $t_r \leq 15$  ns.

Fig.22 Test circuit and reverse recovery time waveform and definition.

Fast soft-recovery rectifiers

BYD43 series

PACKAGE OUTLINE

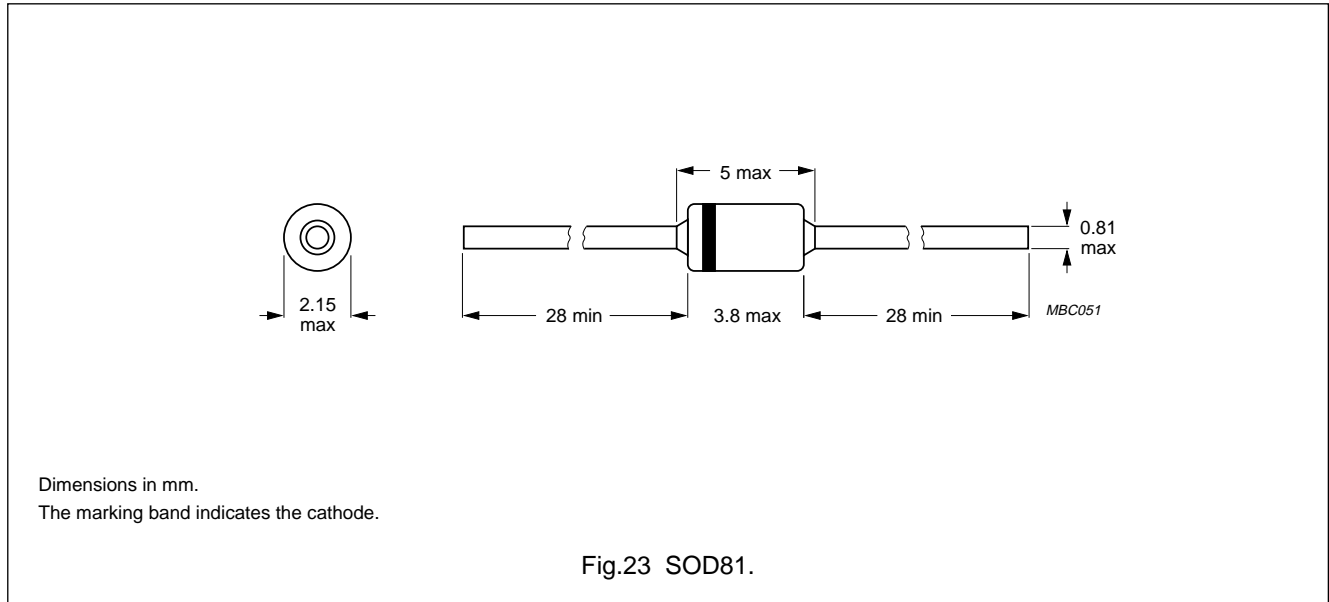

DEFINITIONS

<b>Data Sheet Status</b>	
Objective specification	This data sheet contains target or goal specifications for product development.
Preliminary specification	This data sheet contains preliminary data; supplementary data may be published later.
Product specification	This data sheet contains final product specifications.
<b>Limiting values</b>	
Limiting values given are in accordance with the Absolute Maximum Rating System (IEC 134). Stress above one or more of the limiting values may cause permanent damage to the device. These are stress ratings only and operation of the device at these or at any other conditions above those given in the Characteristics sections of the specification is not implied. Exposure to limiting values for extended periods may affect device reliability.	
<b>Application information</b>	
Where application information is given, it is advisory and does not form part of the specification.	

LIFE SUPPORT APPLICATIONS

These products are not designed for use in life support appliances, devices, or systems where malfunction of these products can reasonably be expected to result in personal injury. Philips customers using or selling these products for use in such applications do so at their own risk and agree to fully indemnify Philips for any damages resulting from such improper use or sale.