

PC923

High Speed Photocoupler for MOS-FET / IGBT Drive

※ Lead forming type (I type) and taping reel type (P type) are also available. (PC923I/PC923P)

※※ TÜV (VDE 0884) approved type is also available as an option.

■ Features

1. Built-in direct drive circuit for MOS-FET/
IGBT drive

(I_{O1P} , I_{O2P} : 0.4A)

2. High speed response

(t_{PLH} , t_{PHL} : MAX. 0.5 μ s)

3. Wide operating supply voltage range

(V_{CC} : 15 to 30V, T_a = -10 to 60°C)

4. High noise reduction type

(CM_H = MIN. - 1 500V/ μ s)

(CM_L = MIN. 1 500V/ μ s)

5. Recognized by UL, file No. E64380

6. High isolation voltage between input
and output (V_{ISO} = 5 000 V_{rms})

■ Applications

1. Inverter controlled air conditioners

■ Outline Dimensions

(Unit : mm)

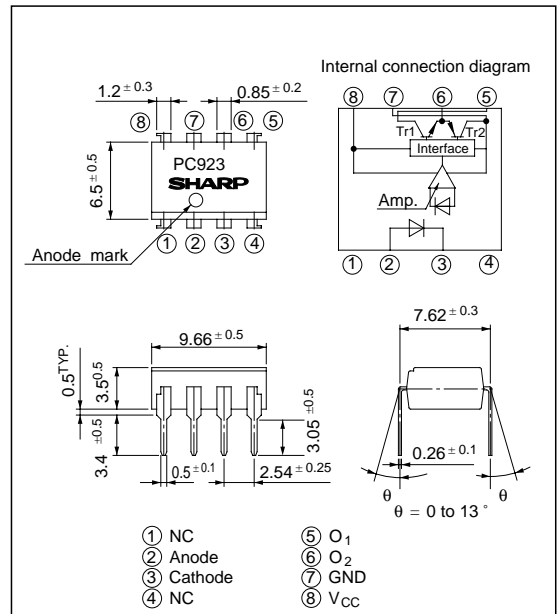

* "OPIC" (Optical IC) is a trademark of the SHARP Corporation.
An OPIC consists of a light-detecting element and signal-processing circuit integrated onto a single chip.

■ Absolute Maximum Ratings

($T_a = T_{opr}$ unless otherwise specified)

Parameter		Symbol	Rating	Unit
Input	Forward current	I_F	20	mA
	*1 Reverse voltage	V_R	6	V
Supply voltage		V_{CC}	35	V
Output	O_1 output current	I_{O1}	0.1	A
	*2 O_1 peak output current	I_{O1P}	0.4	A
	O_2 output current	I_{O2}	0.1	A
	*2 O_2 peak output current	I_{O2P}	0.4	A
	O_1 output voltage	V_{O1}	35	V
	Power dissipation	P_O	500	mW
	Total power dissipation	P_{tot}	550	mW
*3 Isolation voltage		V_{iso}	5 000	V _{rms}
Operating temperature		T_{opr}	- 25 to + 80	°C
Storage temperature		T_{stg}	- 55 to + 125	°C
*4 Soldering temperature		T_{sol}	260	°C

*1 $T_a = 25^\circ\text{C}$

*2 Pulse width $\leq 0.15\mu\text{s}$,
Duty ratio: 0.01

*3 40 to 60% RH, AC for 1 minute,
 $T_a = 25^\circ\text{C}$

*4 For 10 seconds

■ Electro-optical Characteristics

($T_a = T_{opr}$ unless otherwise specified)

Parameter		Symbol	*5 Conditions	MIN.	TYP.	MAX.	Unit	Fig.			
Input	Forward voltage	V_{F1}	$T_a = 25^\circ\text{C}, I_F = 10\text{mA}$	-	1.6	1.75	V	-			
		V_{F2}	$T_a = 25^\circ\text{C}, I_F = 0.2\text{mA}$	1.2	1.5	-	V	-			
	Reverse current	I_R	$T_a = 25^\circ\text{C}, V_R = 5\text{V}$	-	-	10	μA	-			
	Terminal capacitance	C_t	$T_a = 25^\circ\text{C}, V = 0, f = 1\text{MHz}$	-	30	250	pF	-			
Output	Operating supply voltage	V_{CC}	$T_a = -10 \text{ to } 60^\circ\text{C}$	15	-	30	V	-			
				15	-	24	V				
	O ₁ low level output voltage	V_{O1L}	$V_{CC1} = 12\text{V}, V_{CC2} = -12\text{V}$ $I_{O1} = 0.1\text{A}, I_F = 5\text{mA}$	-	0.2	0.4	V	1			
	O ₂ high level output voltage	V_{O2H}	$V_{CC} = V_{O1} = 24\text{V}, I_{O2} = -0.1\text{A}, I_F = 5\text{mA}$	18	21	-	V	2			
	O ₂ low level output voltage	V_{O2L}	$V_{CC} = 24\text{V}, I_{O2} = 0.1\text{A}, I_F = 0$	-	1.2	2.0	V	3			
	O ₁ leak current	I_{O1L}	$T_a = 25^\circ\text{C}, V_{CC} = V_{O1} = 35\text{V}, I_F = 0$	-	-	500	μA	4			
	O ₂ leak current	I_{O2L}	$T_a = 25^\circ\text{C}, V_{CC} = V_{O2} = 35\text{V}, I_F = 5\text{mA}$	-	-	500	μA	5			
	High level supply current	I_{CCH}	$T_a = 25^\circ\text{C}, V_{CC} = 24\text{V}, I_F = 5\text{mA}$	-	6	10	mA	6			
$V_{CC} = 24\text{V}, I_F = 5\text{mA}$			-	-	14	mA					
$T_a = 25^\circ\text{C}, V_{CC} = 24\text{V}, I_F = 0$			-	8	13	mA					
Low level supply current	I_{CCL}	$T_a = 25^\circ\text{C}, V_{CC} = 24\text{V}, I_F = 0$	-	-	17	mA	6				
		$V_{CC} = 24\text{V}, I_F = 0$	-	-	17	mA					
		$V_{CC} = 24\text{V}, I_F = 0$	-	-	17	mA					
Transfer characteristics	*6 "Low→High" threshold input current	I_{FLH}	$T_a = 25^\circ\text{C}, V_{CC} = 24\text{V}$	0.3	1.5	3.0	mA	7			
			$V_{CC} = 24\text{V}$	0.2	-	5.0	mA				
	Response time	Isolation resistance	R_{ISO}	$T_a = 25^\circ\text{C}, \text{DC} = 500\text{V}, 40 \text{ to } 60\% \text{RH}$	5×10^{10}	10^{11}	-	Ω	-		
				"Low→High" propagation delay time	t_{PLH}	$T_a = 25^\circ\text{C}, V_{CC} = 24\text{V}, I_F = 5\text{mA}$	-	0.3	0.5	μs	8
				"High→Low" propagation delay time	t_{PHL}		-	0.3	0.5	μs	
				Rise time	t_r		-	0.2	0.5	μs	
	Fall time	t_f	$R_C = 47\Omega, C_G = 3000\text{pF}$	-	0.2	0.5	μs				
	Instantaneous common mode rejection voltage "Output: High level"	CH_M	$T_a = 25^\circ\text{C}, V_{CM} = 600\text{V}(\text{peak})$ $I_F = 5\text{mA}, V_{CC} = 24\text{V}, \Delta V_{O2H} = 2.0\text{V}$	-	-30	-	kV/ μs	9			
$T_a = 25^\circ\text{C}, V_{CM} = 600\text{V}(\text{peak})$ $I_F = 0, V_{CC} = 24\text{V}, \Delta V_{O2L} = 2.0\text{V}$			-	30	-	kV/ μs					

*5 When measuring output and transfer characteristics, connect a by-pass capacitor (0.01 μF or more) between V_{CC} and GND near the **PC923**.

*6 I_{FLH} represents forward current when O₂output goes from low to high.

■ Truth Table

Input	O ₂ Output	Tr. 1	Tr. 2
ON	High level	ON	OFF
OFF	Low level	OFF	ON

■ Test Circuit

Fig. 1

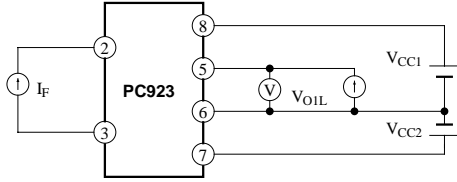

Fig. 3

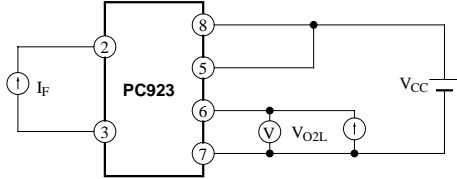

Fig. 5

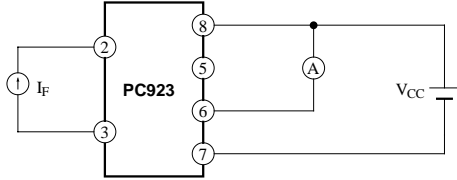

Fig. 7

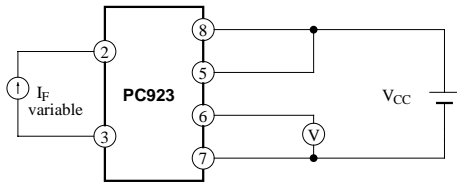

Fig. 9

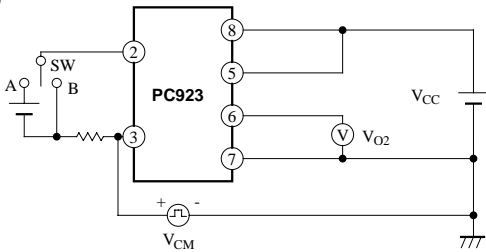

Fig. 2

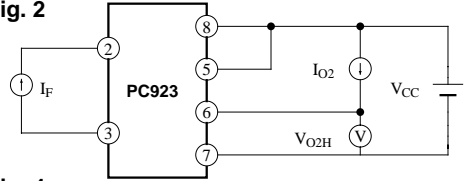

Fig. 4

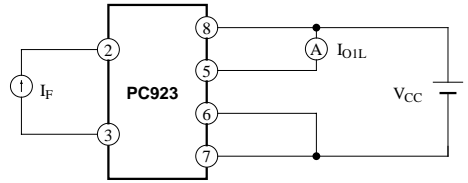

Fig. 6

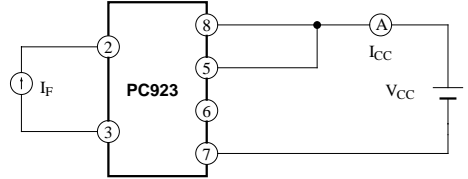

Fig. 8

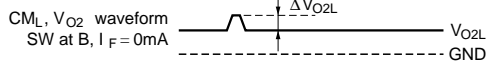
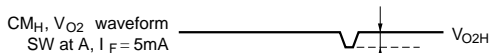
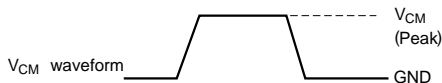
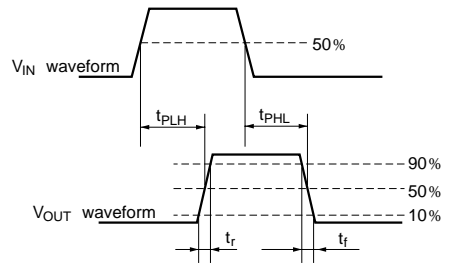
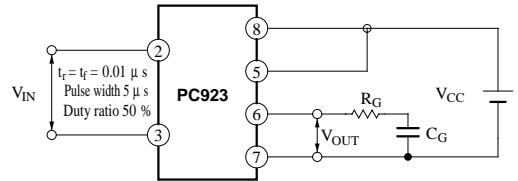

Fig.10 Forward Current vs. Ambient Temperature

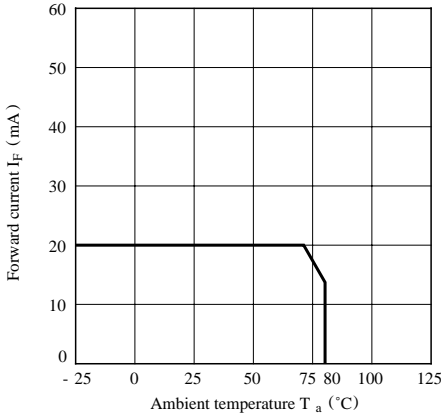

Fig.11 Power Dissipation vs. Ambient Temperature

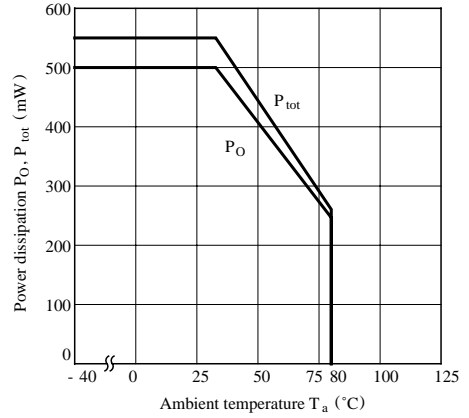

Fig.12 Forward Current vs. Forward Voltage

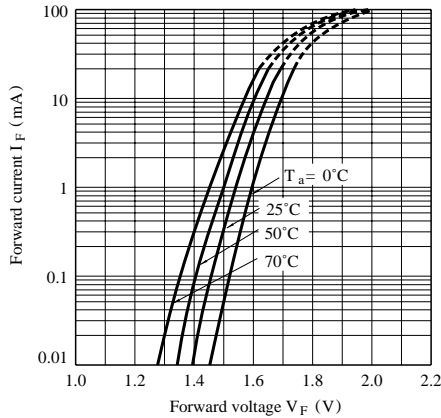

Fig.13 “Low → High” Relative Threshold Input Current vs. Supply Voltage

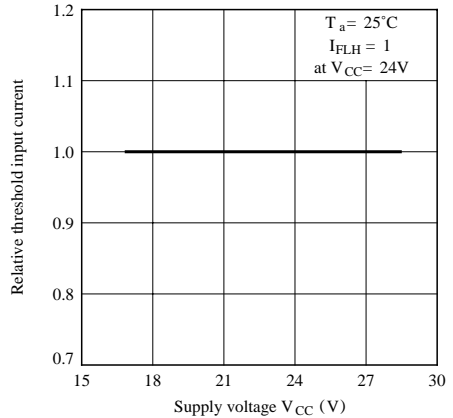

Fig.14 “Low → High” Relative Threshold Input Current vs. Ambient Temperature

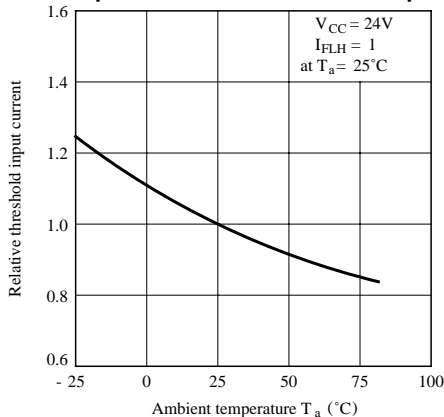

Fig.15 O₁ Low Level Output Voltage vs. O₁ Output Current

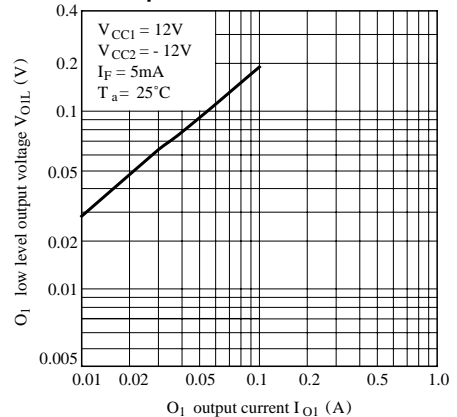

Fig.16 O₁ Low Level Output Voltage vs. Ambient Temperature

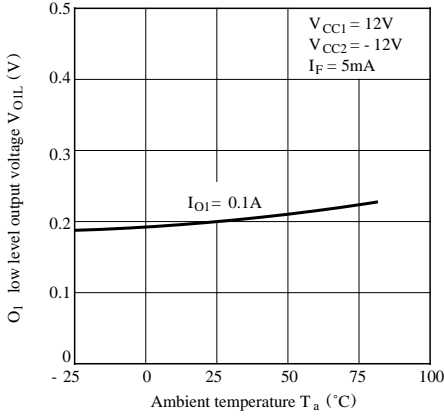

Fig.17 O₂ High Level Output Voltage vs. Supply Voltage

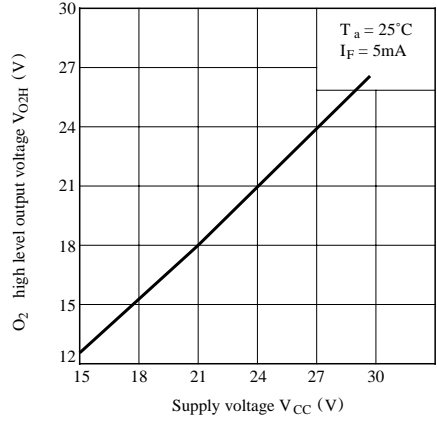

Fig.18 O₂ High Level Output Voltage vs. Ambient Temperature

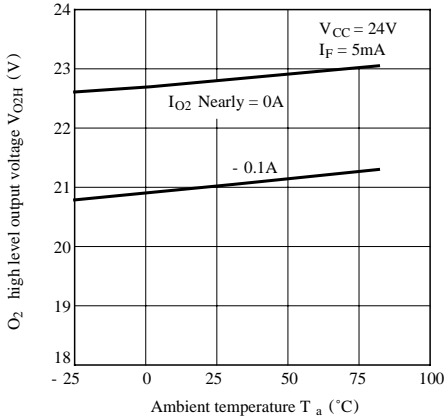

Fig.19 O₂ Low Level Output Voltage vs. O₂ Output Current

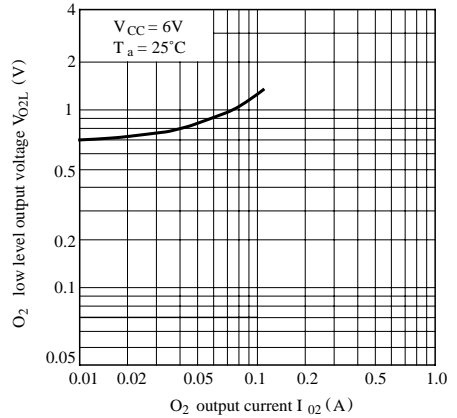

Fig.20 O₂ Low Level Output Voltage vs. Ambient Temperature

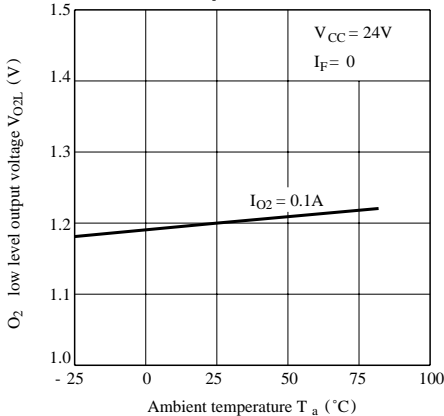

Fig.21 High Level Supply Current vs. Supply Voltage

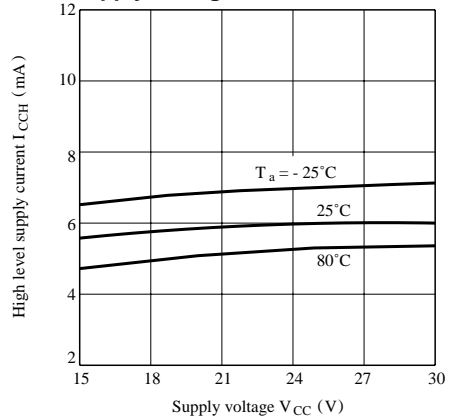

Fig.22 Low Level Supply Current vs. Supply Voltage

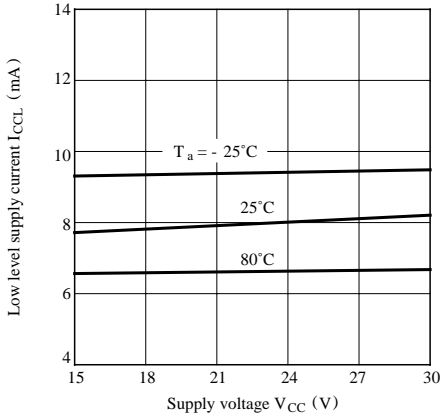

Fig.23 Propagation Delay Time vs. Forward current

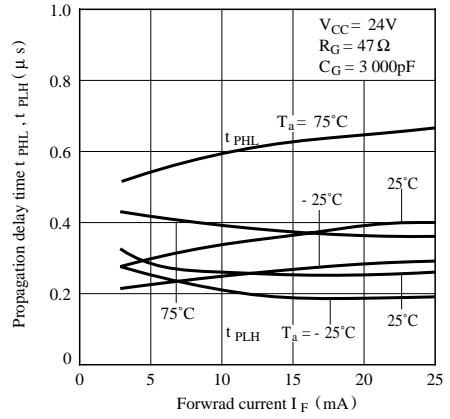
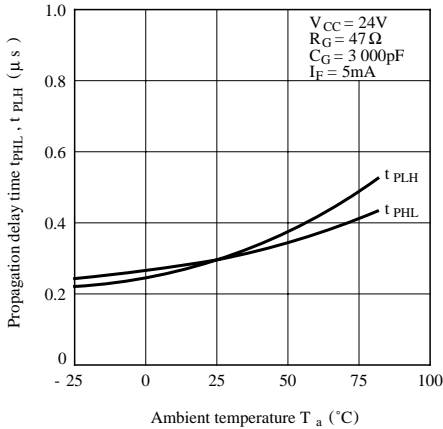
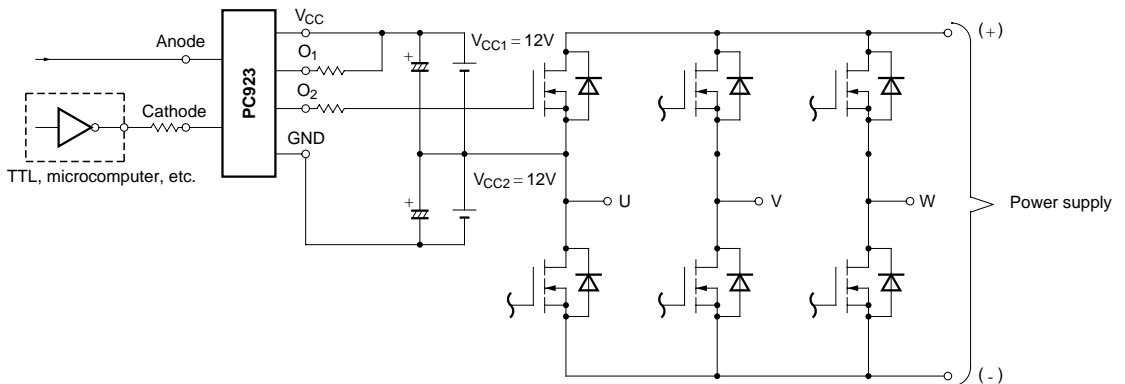

Fig.24 Propagation Delay Time vs. Ambient Temperature



■ **Application Circuit (For Power MOS-FET Driving Inverter)**



● Please refer to the chapter “Precautions for Use.”