

# TIL197, TIL198, TIL199, TIL197A, TIL198A, TIL199A TIL197B, TIL198B, TIL199B SINGLE/DUAL/QUAD CHANNEL OPTOCOUPLEDERS/OPTOISOLATORS

SOOS023 D3437, MAY 1990

- Gallium-Arsenide Diode Infrared Source
- Source Is Optically Coupled to Silicon N-P-N Darlington Phototransistor
- Choice of One, Two or Four Channels
- Choice of Three Current-Transfer Ratios
- High-Voltage Electrical Isolation 3.535 kV Peak (2.5 kV rms)
- Plastic Dual-In-Line Packages
- UL Listed – File #E65085

## description

These optocouplers consist of a gallium-arsenide light-emitting diode and a silicon n-p-n Darlington phototransistor per channel. The TIL197 has one channel in a 4-pin package, the TIL198 has two channels in a 8-pin package, and the TIL199 has four channels in a 16-pin package. The standard devices, TIL197, TIL198, and TIL199, are tested for a current-transfer ratio of 500% minimum. Devices selected for a current-transfer ratio of 1000% and 1500% minimum are designated with the suffixes A and B, respectively.

## mechanical data

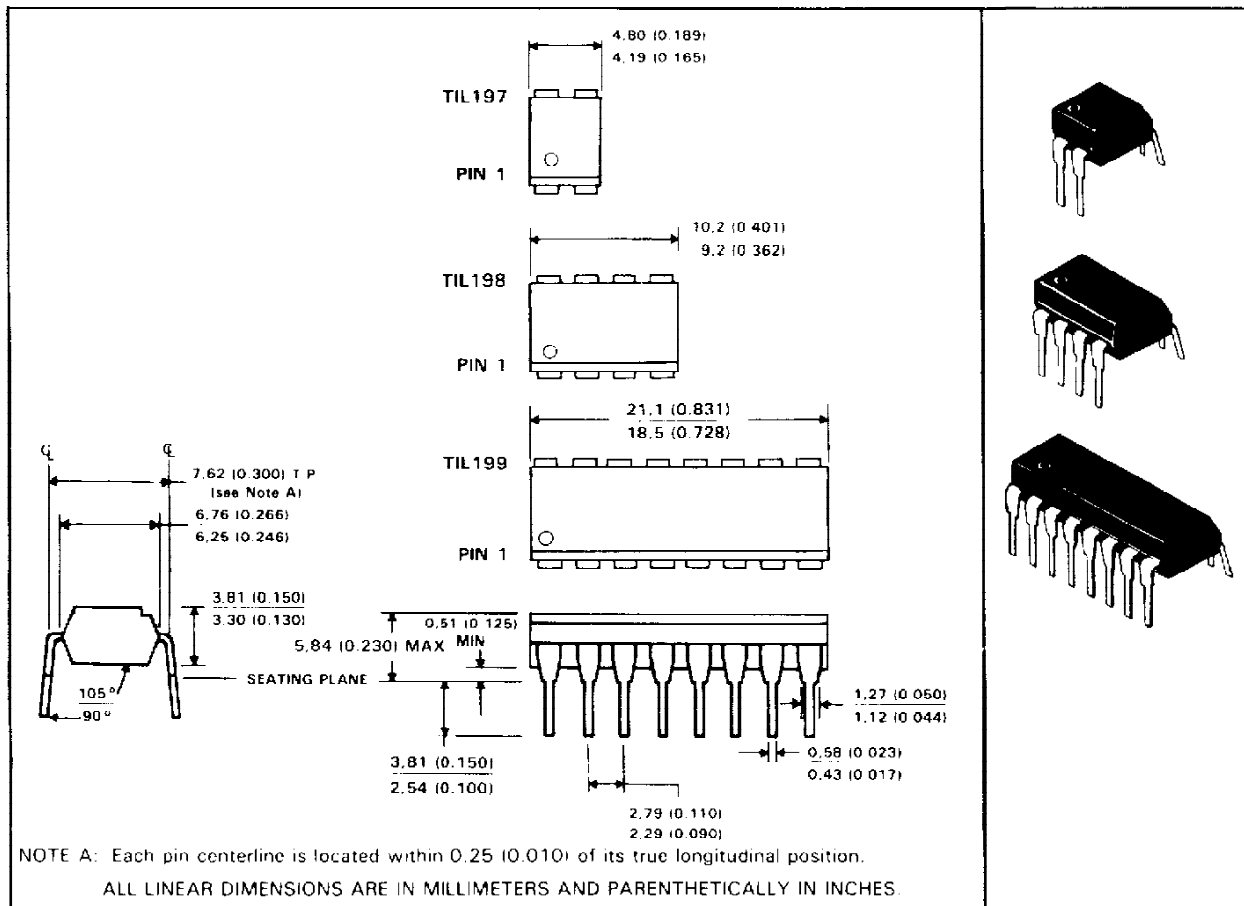

PRODUCTION DATA documents contain information current as of publication date. Products conform to specifications per the terms of Texas Instruments standard warranty. Production processing does not necessarily include testing of all parameters.

**TEXAS  
INSTRUMENTS**

POST OFFICE BOX 655303 • DALLAS, TEXAS 75265

Copyright © 1990, Texas Instruments Incorporated

**TIL197, TIL198, TIL199, TIL197A, TIL198A, TIL199A  
TIL197B, TIL198B, TIL199B  
SINGLE/DUAL/QUAD CHANNEL OPTOCOUPLERS/OPTOISOLATORS**

**schematic diagrams**

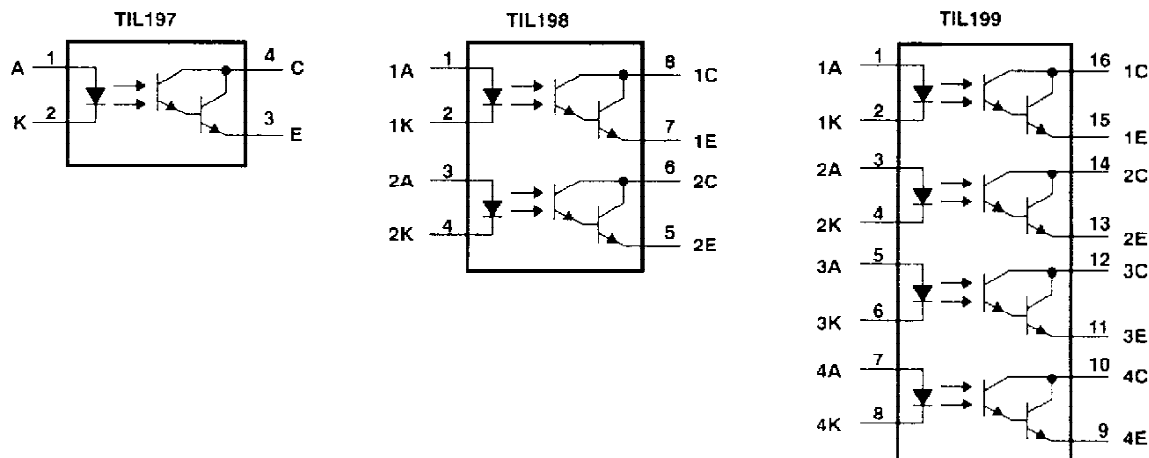

**absolute maximum ratings at 25°C free-air temperature (unless otherwise noted)**

Input-to-output voltage (see Note 1)	±3.535 kV peak or dc (±2.5 kV rms)
Collector-emitter voltage (see Note 2)	35 V
Emitter-collector voltage	7 V
Input diode reverse voltage	5 V
Input diode continuous forward current at (or below) 25°C free-air temperature (see Note 3)	50 mA
Continuous power dissipation at (or below) 25°C free-air temperature:	
Phototransistor (see Note 4)	150 mW
Input diode plus phototransistor per channel (see Note 5)	200 mW
Storage temperature range	- 55°C to 125°C
Lead temperature 1,6 mm (1/16 inch) from case for 10 seconds	260°C

- NOTE 1: This rating applies for sine-wave operation at 50 or 60 Hz. Service capability is verified by testing in accordance with UL requirements.  
 2. This value applies when the base-emitter diode is open circuited.  
 3. Derate linearly to 100°C free air temperature at the rate of 0.67 mA/°C.  
 4. Derate linearly to 100°C free-air temperature at the rate of 2 mW/°C.  
 5. Derate linearly to 100°C free-air temperature at the rate of 2.67 mW/°C.

**electrical characteristics at 25°C free-air temperature range (unless otherwise noted)**

PARAMETER		TEST CONDITIONS	MIN	TYP	MAX	UNIT
$V_{(BR)CEO}$	Collector-emitter breakdown voltage	$I_C = 0.5 \text{ mA}$ , $I_F = 0$	35			V
$V_{(BR)ECO}$	Emitter-collector breakdown voltage	$I_C = 100 \mu\text{A}$ , $I_F = 0$	7			V
$I_R$	Input diode static reverse current	$V_R = 5 \text{ V}$			10	$\mu\text{A}$
$I_{C(off)}$	Off-state collector current	$V_{CE} = 10 \text{ V}$ , $I_F = 0$			100	nA
CTR	Current transfer ratio	TIL197, TIL198, TIL199		500%		
		TIL197A, TIL198A, TIL199A	$I_F = 2 \text{ mA}$ , $V_{CE} = 1 \text{ V}$	1000%		
		TIL197B, TIL198B, TIL199B		1500%		
$V_F$	Input diode static forward voltage	$I_F = 20 \text{ mA}$			1.4	V
$V_{CE(sat)}$	Collector-emitter saturation voltage	$I_F = 10 \text{ mA}$ , $I_C = 50 \text{ mA}$			1	V
$C_{io}$	Input-to-output capacitance	$V_{in-out} = 0$ , $f = 1 \text{ MHz}$ , See Note 6		1		pF
$r_{io}$	Input-to-output internal resistance	$V_{in-out} = \pm 1 \text{ kV}$ , See Note 6		$10^{11}$		$\Omega$

NOTE 6. These parameters are measured between all input-diode leads shorted together and all phototransistor leads shorted together.

**TIL197, TIL198, TIL199, TIL197A, TIL198A, TIL199A  
TIL197B, TIL198B, TIL199B  
SINGLE/DUAL/QUAD CHANNEL OPTOCOUPLERS/OPTOISOLATORS**

switching characteristics at 25°C free-air temperature

PARAMETER	TEST CONDITIONS	TYP	UNIT
$t_r$ Rise time	$V_{CC} = 10\text{ V}$ , $I_{C(on)} = 10\text{ mA}$ ,	100	$\mu\text{s}$
$t_f$ Fall time	$R_L = 100\ \Omega$ , See Figure 1	100	

**PARAMETER MEASUREMENT INFORMATION**

Adjust amplitude of input pulse for  
 $I_{C(on)} = 10\text{ mA}$

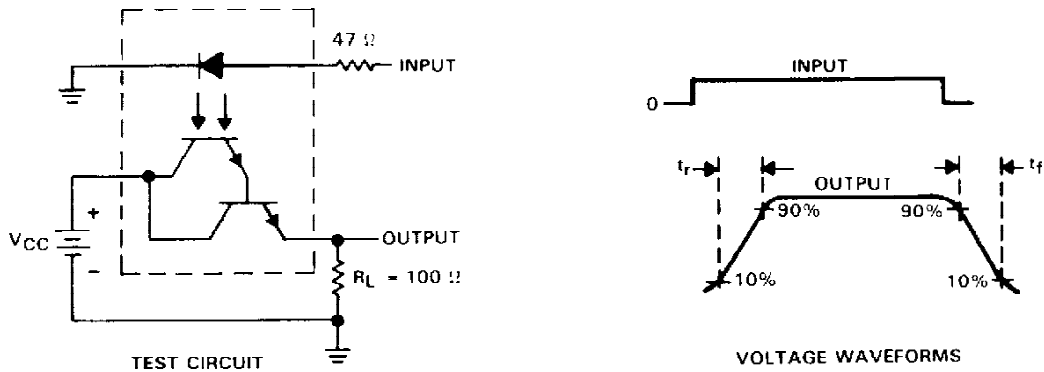

NOTES: A. The input waveform is supplied by a generator with the following characteristics:  $Z_0 = 50\ \Omega$ ,  $t_r \leq 15\text{ ns}$ , duty cycle = 1%,  $t_W = 500\ \mu\text{s}$ .  
B. The output waveform is monitored on an oscilloscope with the following characteristics:  $t_r \leq 12\text{ ns}$ ,  $R_{in} > 1\text{ M}\Omega$ ,  $C_{in} < 20\text{ pF}$ .

**Figure 1. Switching Times**

TIL197, TIL198, TIL199, TIL197A, TIL198A, TIL199A  
 TIL197B, TIL198B, TIL199B  
 SINGLE/DUAL/QUAD CHANNEL OPTOCOUPPLERS/OPTOISOLATORS

TYPICAL CHARACTERISTICS

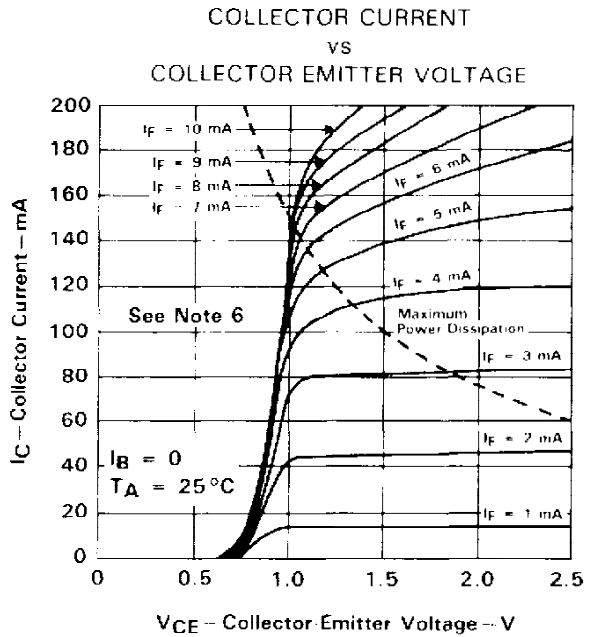
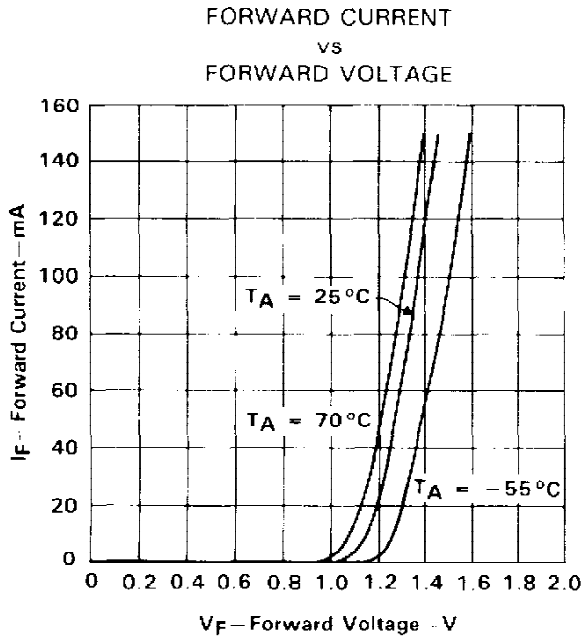

NOTE 6: Pulse operation is required for operation beyond limits shown by the dashed line.

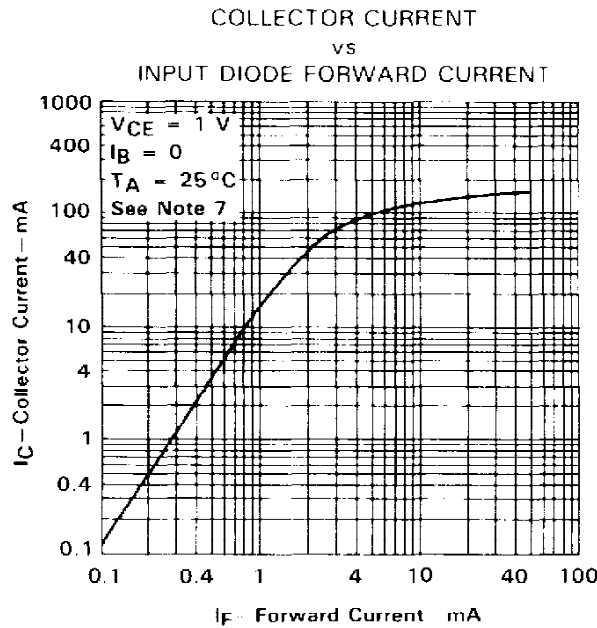

NOTE 7: These parameters were measured using pulse techniques  $t_w = 1$  ms, duty cycle  $\approx 2\%$ .

TIL197, TIL198, TIL199, TIL197A, TIL198A, TIL199A  
 TIL197B, TIL198B, TIL199B  
 SINGLE/DUAL/QUAD CHANNEL OPTOCOUPPLERS/OPTOISOLATORS

TYPICAL CHARACTERISTICS

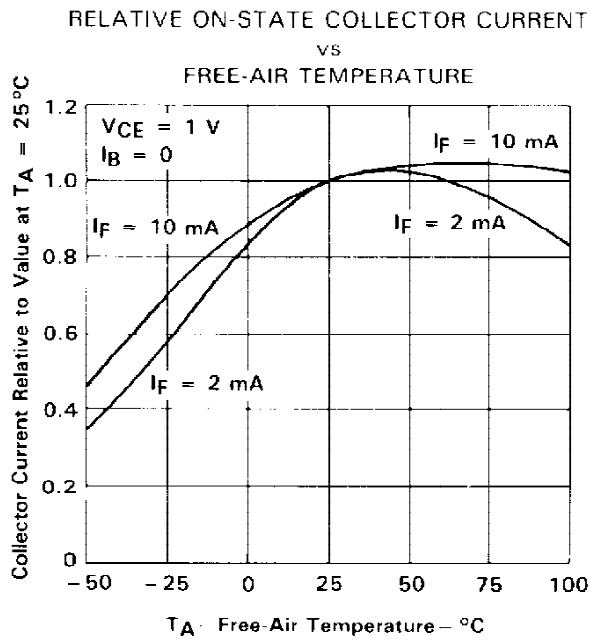

Figure 5

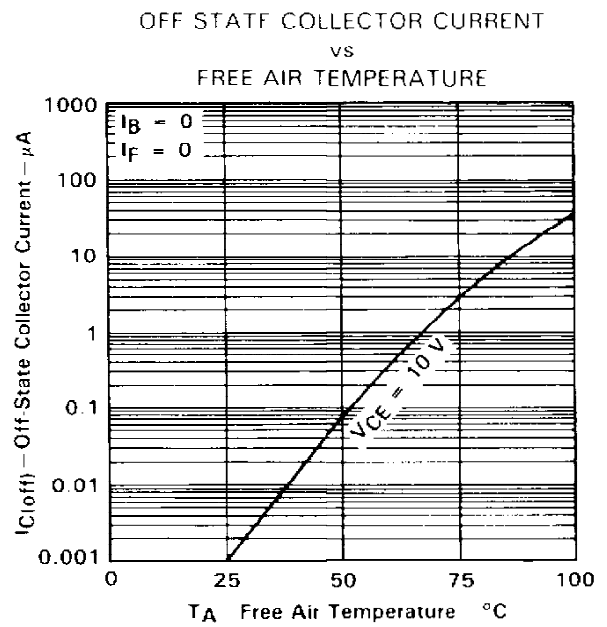

Figure 6

## IMPORTANT NOTICE

Texas Instruments (TI) reserves the right to make changes to its products or to discontinue any semiconductor product or service without notice, and advises its customers to obtain the latest version of relevant information to verify, before placing orders, that the information being relied on is current.

TI warrants performance of its semiconductor products and related software to the specifications applicable at the time of sale in accordance with TI's standard warranty. Testing and other quality control techniques are utilized to the extent TI deems necessary to support this warranty. Specific testing of all parameters of each device is not necessarily performed, except those mandated by government requirements.

Certain applications using semiconductor products may involve potential risks of death, personal injury, or severe property or environmental damage ("Critical Applications").

TI SEMICONDUCTOR PRODUCTS ARE NOT DESIGNED, INTENDED, AUTHORIZED, OR WARRANTED TO BE SUITABLE FOR USE IN LIFE-SUPPORT APPLICATIONS, DEVICES OR SYSTEMS OR OTHER CRITICAL APPLICATIONS.

Inclusion of TI products in such applications is understood to be fully at the risk of the customer. Use of TI products in such applications requires the written approval of an appropriate TI officer. Questions concerning potential risk applications should be directed to TI through a local SC sales office.

In order to minimize risks associated with the customer's applications, adequate design and operating safeguards should be provided by the customer to minimize inherent or procedural hazards.

TI assumes no liability for applications assistance, customer product design, software performance, or infringement of patents or services described herein. Nor does TI warrant or represent that any license, either express or implied, is granted under any patent right, copyright, mask work right, or other intellectual property right of TI covering or relating to any combination, machine, or process in which such semiconductor products or services might be or are used.

## **IMPORTANT NOTICE**

Texas Instruments (TI) reserves the right to make changes to its products or to discontinue any semiconductor product or service without notice, and advises its customers to obtain the latest version of relevant information to verify, before placing orders, that the information being relied on is current.

TI warrants performance of its semiconductor products and related software to the specifications applicable at the time of sale in accordance with TI's standard warranty. Testing and other quality control techniques are utilized to the extent TI deems necessary to support this warranty. Specific testing of all parameters of each device is not necessarily performed, except those mandated by government requirements.

Certain applications using semiconductor products may involve potential risks of death, personal injury, or severe property or environmental damage ("Critical Applications").

**TI SEMICONDUCTOR PRODUCTS ARE NOT DESIGNED, INTENDED, AUTHORIZED, OR WARRANTED TO BE SUITABLE FOR USE IN LIFE-SUPPORT APPLICATIONS, DEVICES OR SYSTEMS OR OTHER CRITICAL APPLICATIONS.**

Inclusion of TI products in such applications is understood to be fully at the risk of the customer. Use of TI products in such applications requires the written approval of an appropriate TI officer. Questions concerning potential risk applications should be directed to TI through a local SC sales office.

In order to minimize risks associated with the customer's applications, adequate design and operating safeguards should be provided by the customer to minimize inherent or procedural hazards.

TI assumes no liability for applications assistance, customer product design, software performance, or infringement of patents or services described herein. Nor does TI warrant or represent that any license, either express or implied, is granted under any patent right, copyright, mask work right, or other intellectual property right of TI covering or relating to any combination, machine, or process in which such semiconductor products or services might be or are used.