

DATA SHEET

BLW98 UHF linear power transistor

Product specification

August 1986

UHF linear power transistor

BLW98

DESCRIPTION

N-P-N silicon planar epitaxial transistor primarily intended for use in linear u.h.f. amplifiers of TV transposers and transmitters in band IV-V, as well as for driver stages in tube systems.

FEATURES:

- diffused emitter ballasting resistors for an optimum temperature profile;
- gold sandwich metallization ensures excellent reliability.

The transistor has a 1/4" capstan envelope with ceramic cap. All leads are isolated from the stud.

QUICK REFERENCE DATA

R.F. performance in linear amplifier

MODE OF OPERATION	f_{vision} MHz	V_{CE} V	I_{c} mA	T_{h} °C	$d_{\text{im}}^{(1)}$ dB	$P_{\text{o sync}}^{(1)}$ W	G_{p} dB
class-A	860	25	850	70	-60	> 3,5	> 6,5
class-A	860	25	850	25	-60	typ. 4,4	typ. 7,0

Note

1. Three-tone test method (vision carrier -8 dB, sound carrier -7 dB, sideband signal -16 dB), zero dB corresponds to peak sync level.

PIN CONFIGURATION

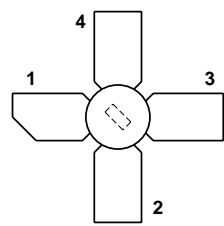

Top view MBK187

Fig.1 Simplified outline. SOT122A.

PINNING - SOT122A.

PIN	DESCRIPTION
1	collector
2	emitter
3	base
4	emitter

PRODUCT SAFETY This device incorporates beryllium oxide, the dust of which is toxic. The device is entirely safe provided that the BeO disc is not damaged.

UHF linear power transistor

BLW98

RATINGS

Limiting values in accordance with the Absolute Maximum System (IEC 134)

Collector-emitter voltage

(peak value); $V_{BE} = 0$

V_{CESM} max. 50 V

open base

V_{CEO} max. 27 V

Emitter-base voltage (open collector)

V_{EBO} max. 3,5 V

Collector current

d.c.

I_C max. 2 A

(peak value); $f > 1$ MHz

I_{CM} max. 4 A

Total power dissipation at $T_h = 70$ °C

P_{tot} max. 21,5 W

Storage temperature

T_{stg} -65 to +150 °C

Operating junction temperature

T_j max. 200 °C

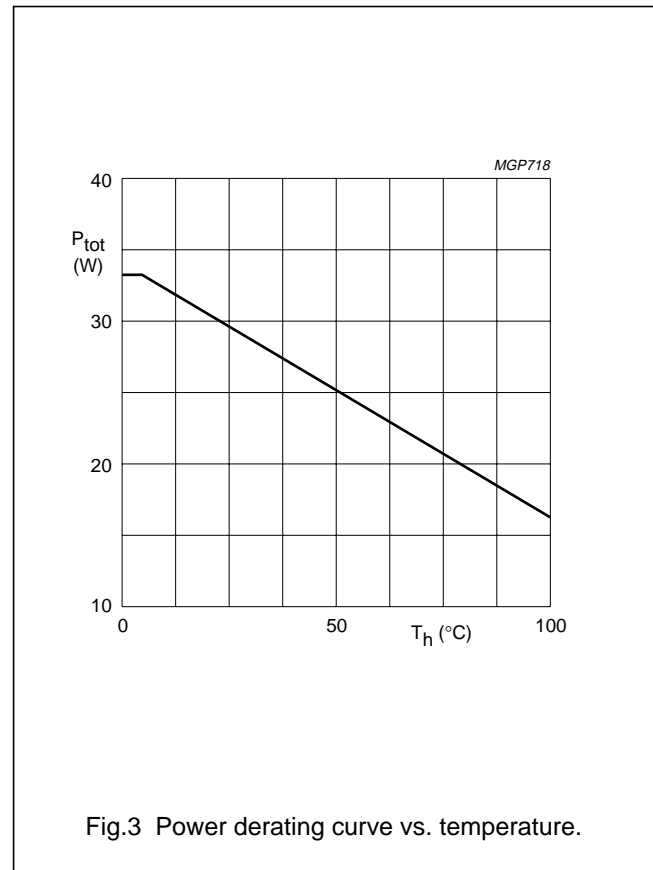
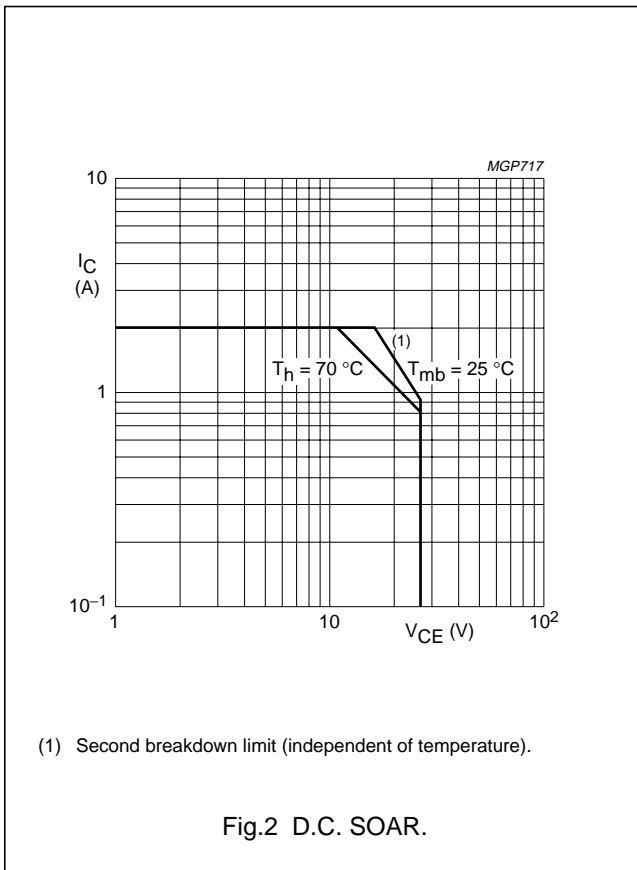

THERMAL RESISTANCE

(dissipation = 21,25 W; $T_{mb} = 82,75$ °C, $T_h = 70$ °C)

From junction to mounting base

$R_{th\ j-mb}$ = 5,45 K/W

From mounting base to heatsink

$R_{th\ mb-h}$ = 0,6 K/W

UHF linear power transistor

BLW98

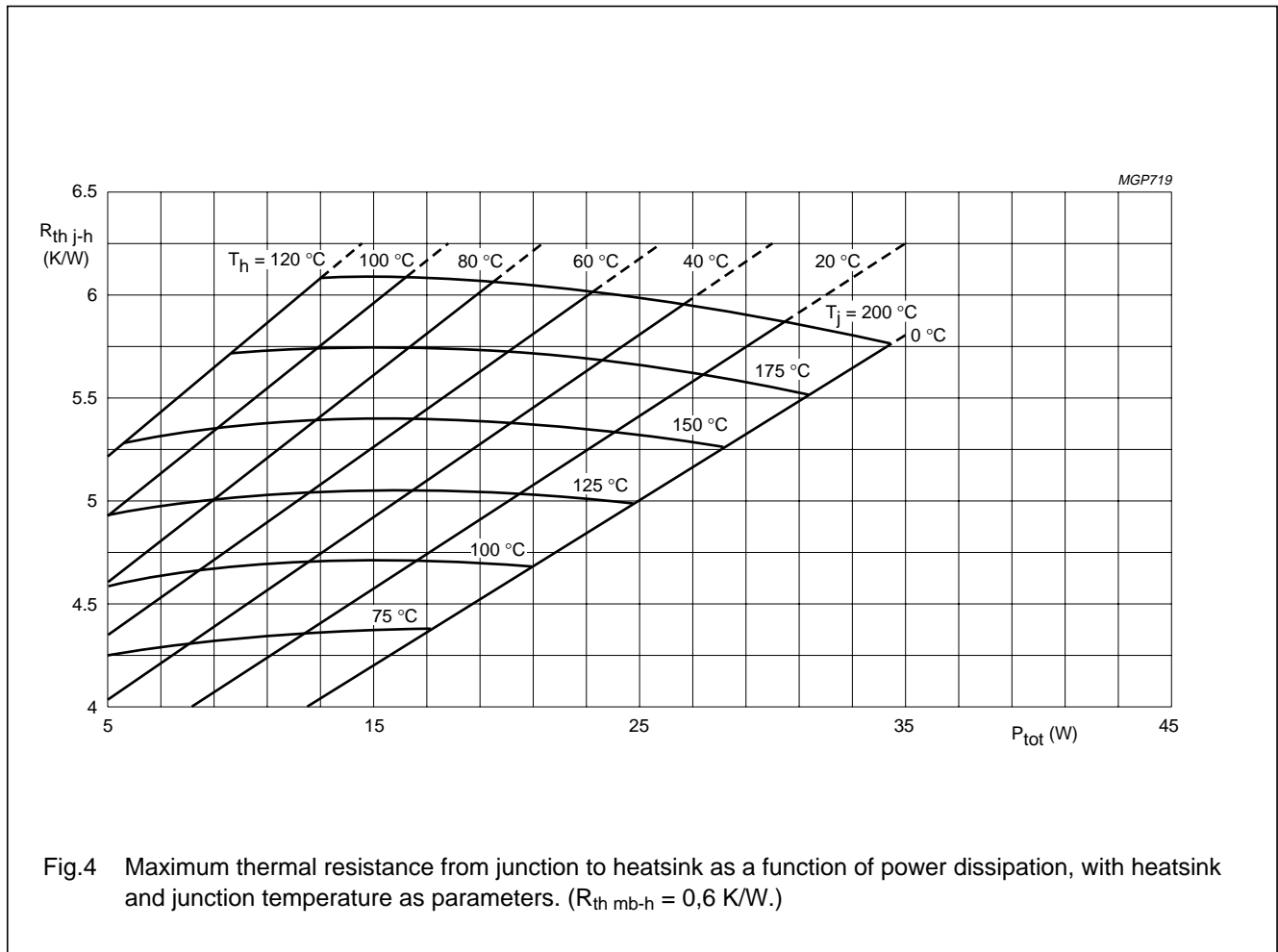

Fig.4 Maximum thermal resistance from junction to heatsink as a function of power dissipation, with heatsink and junction temperature as parameters. ($R_{th\ mb-h} = 0,6\ K/W$.)

Example

Nominal class-A operation (without r.f. signal): $V_{CE} = 25\ V$; $I_C = 850\ mA$; $T_h = 70\ ^\circ C$.

Fig.4 shows:	$R_{th\ j-h}$	max.	6,05	K/W
	T_j	max.	200	°C
Typical device:	$R_{th\ j-h}$	typ.	5,35	K/W
	T_j	typ.	183	°C

UHF linear power transistor

BLW98

CHARACTERISTICS

$T_j = 25\text{ }^\circ\text{C}$ unless otherwise specified

Collector-emitter breakdown voltage

$V_{BE} = 0; I_C = 10\text{ mA}$

open base, $I_C = 25\text{ mA}$

$V_{(BR)CES} > 50\text{ V}$

$V_{(BR)CEO} > 27\text{ V}$

Emitter-base breakdown voltage

open collector, $I_E = 5\text{ mA}$

$V_{(BR)EBO} > 3,5\text{ V}$

D.C. current gain⁽¹⁾

$I_C = 850\text{ mA}; V_{CE} = 25\text{ V}$

$h_{FE} > 15$
typ. 40

Collector-emitter saturation voltage⁽¹⁾

$I_C = 500\text{ mA}; I_B = 100\text{ mA}$

V_{CEsat} typ. 0,25 V

Transition frequency at $f = 500\text{ MHz}$ ⁽²⁾

$-I_E = 850\text{ mA}; V_{CB} = 25\text{ V}$

f_T typ. 2,5 GHz

Collector capacitance at $f = 1\text{ MHz}$

$I_E = I_e = 0; V_{CB} = 25\text{ V}$

C_c typ. 24 pF
< 30 pF

Feedback capacitance at $f = 1\text{ MHz}$

$I_C = 50\text{ mA}; V_{CE} = 25\text{ V}$

C_{re} typ. 15 pF

Collector-stud capacitance

C_{CS} typ. 1,2 pF

Notes

1. Measured under pulse conditions: $t_p \leq 300\text{ }\mu\text{s}; \delta \leq 0,02$.
2. Measured under pulse conditions: $t_p \leq 50\text{ }\mu\text{s}; \delta \leq 0,01$.

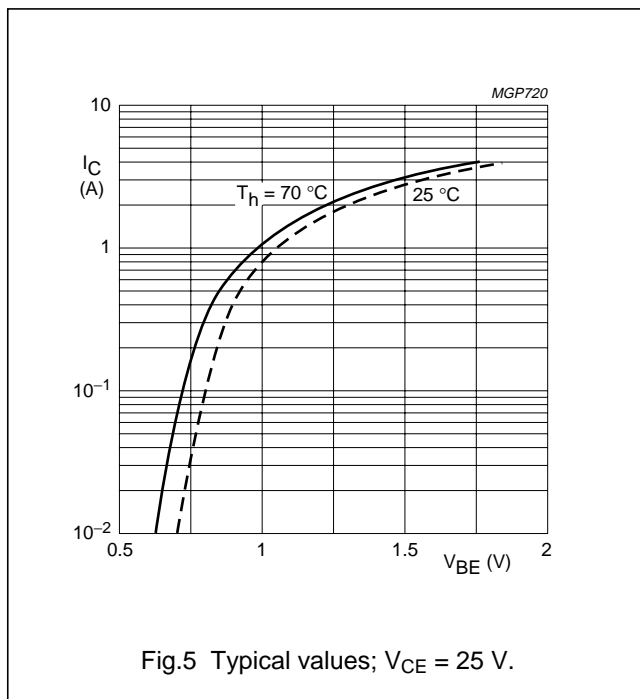

UHF linear power transistor

BLW98

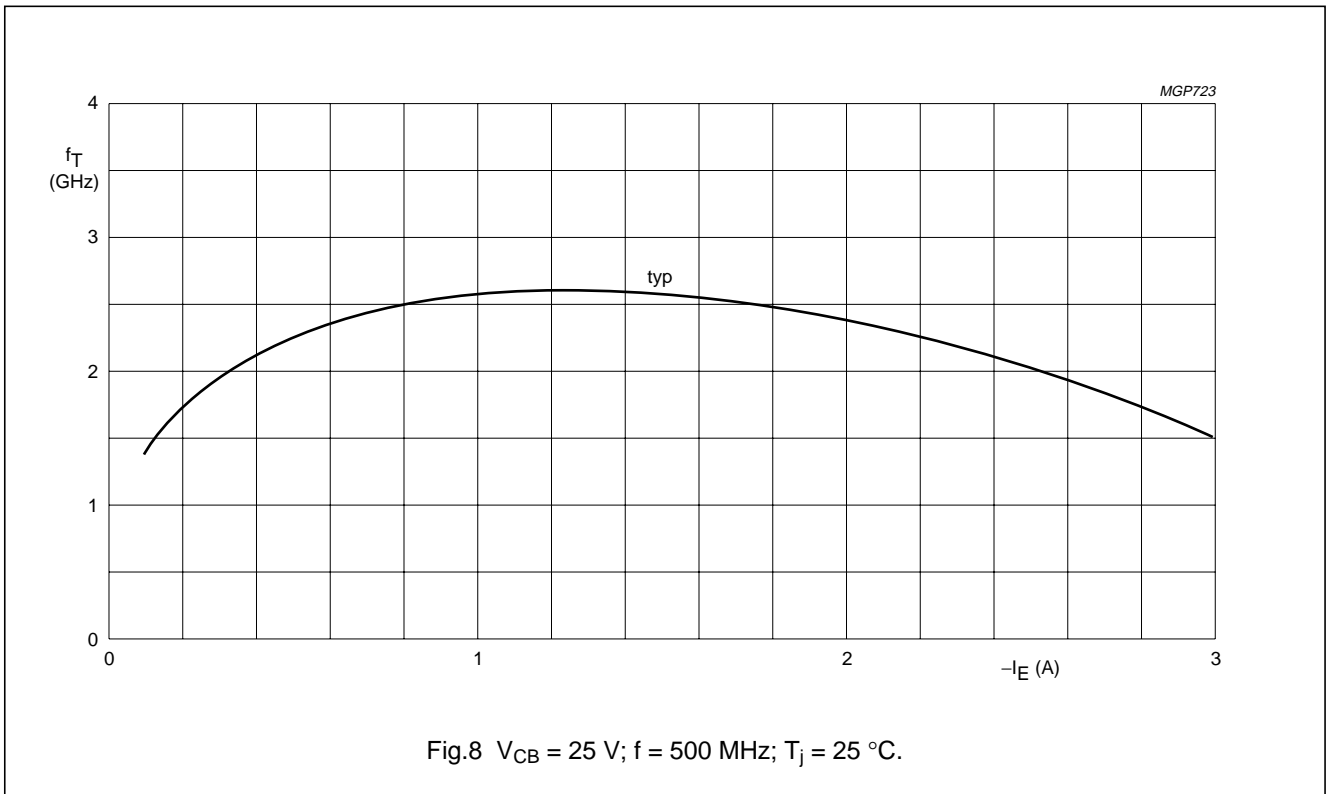
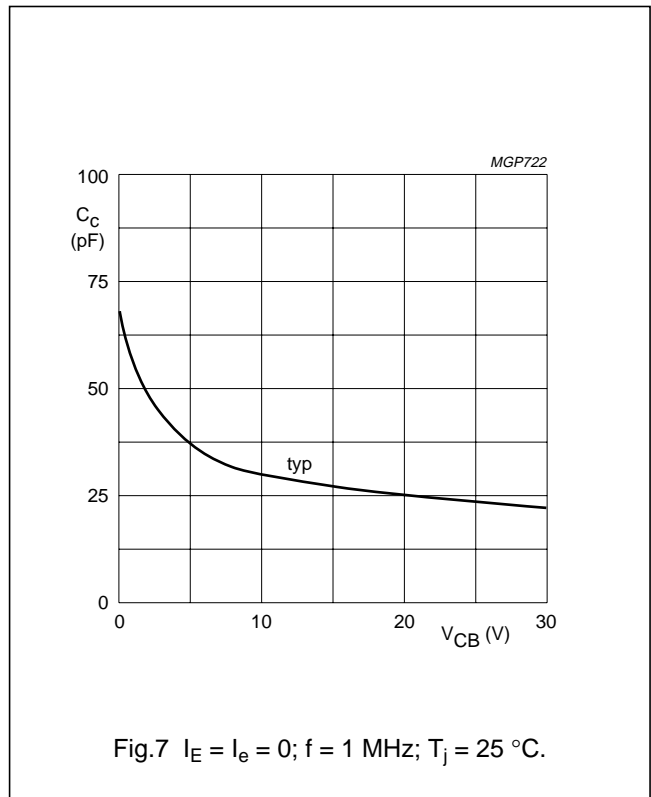
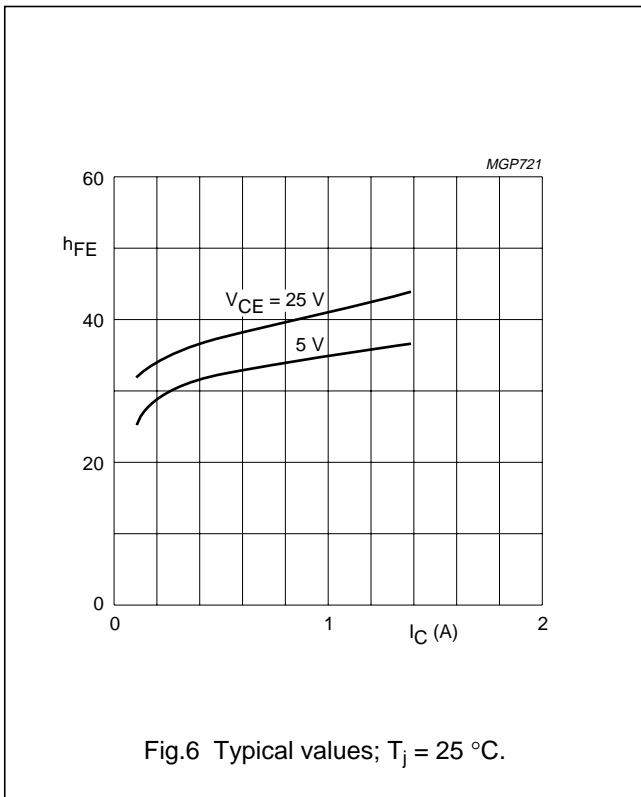

UHF linear power transistor

BLW98

APPLICATION INFORMATION

R.F. performance in u.h.f. class-A operation (linear power amplifier)

f_{vision} (MHz)	V_{CE} (V)	I_{C} (mA)	T_{h} (°C)	d_{im} (dB) ⁽¹⁾	$P_{\text{o sync}}$ (W) ⁽¹⁾	G_{P} (dB)
860	25	850	70	-60	> 3,5	> 6,5
860	25	850	70	-60	typ. 3,8	typ. 7,0
860	25	850	25	-60	typ. 4,4	typ. 7,0

Note

1. Three-tone test method (vision carrier -8 dB, sound carrier -7 dB, sideband signal -16 dB), zero dB corresponds to peak sync level.

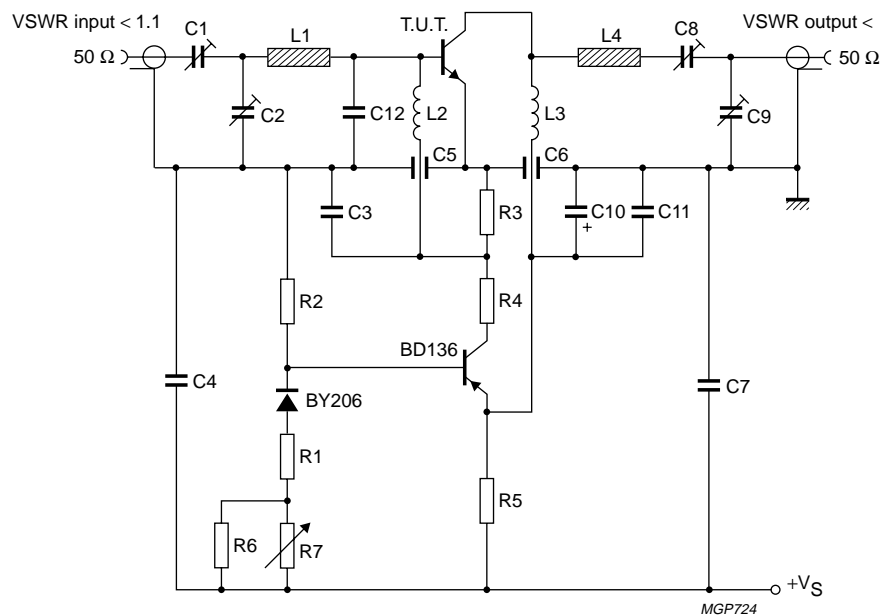

Fig.9 Class-A test circuit at $f_{\text{vision}} = 860$ MHz.

UHF linear power transistor**BLW98**

List of components:

- C1 = C2 = 1,4 to 5,5 pF film dielectric trimmer (cat. no. 2222 809 09001)
C3 = C4 = 100 nF polyester capacitor
C5 = C6 = 1 nF feed-through capacitor
C7 = 5,6 pF ceramic capacitor
C8 = 2 to 18 pF film dielectric trimmer (cat. no. 2222 809 09003)
C9 = 2 to 9 pF film dielectric trimmer (cat. no. 2222 809 09002)
C10 = 10 μ F/40 V solid aluminium electrolytic capacitor
C11 = 470 nF polyester capacitor
C12 = 2 \times 3,3 pF chip capacitors (in parallel)
R1 = 150 Ω carbon resistor (0,25 W) R5 = 4 \times 12 Ω carbon resistors in parallel (1 W each)
R2 = 1,8 k Ω carbon resistor (0,5 W) R6 = 1 k Ω carbon resistor (0,25 W)
R3 = 33 Ω carbon resistor (0,5 W) R7 = 220 Ω carbon potentiometer (0,25 W)
R4 = 220 Ω carbon resistor (1 W)
L1 = stripline (13,6 mm \times 6,9 mm)
L2 = microchoke 0,47 μ H (cat. no. 4322 057 04770)
L3 = 1 turn Cu wire (1 mm); internal diameter 5,5 mm; leads 2 \times 5 mm
L4 = stripline (40,8 mm \times 6,9 mm)

L1 and L4 are striplines on a double Cu-clad printed-circuit board with PTFE fibre-glass dielectric ($\epsilon_r = 2,74$); thickness 1,5 mm.

UHF linear power transistor

BLW98

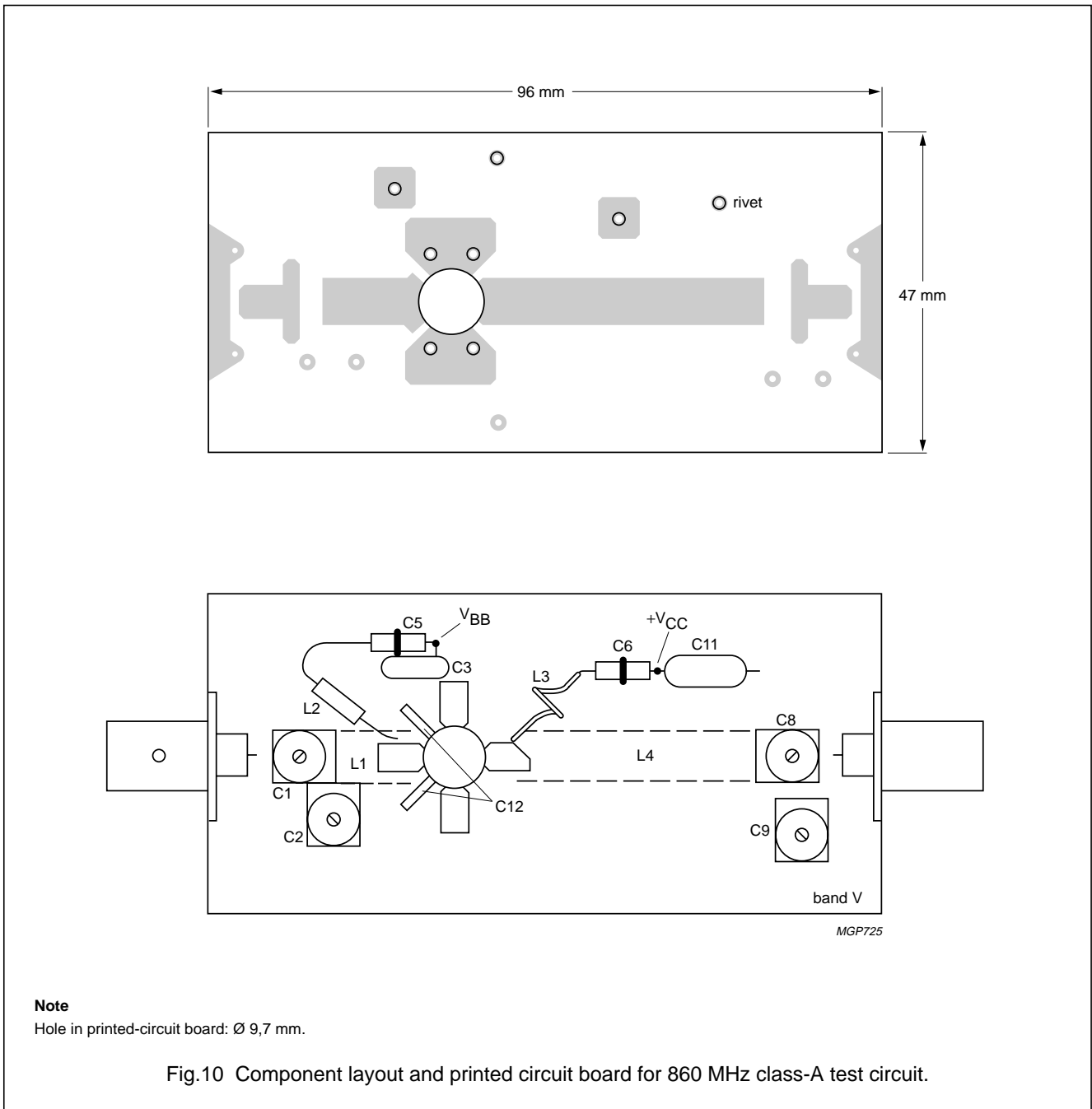

The circuit and the components are on one side of the PTFE fibre-glass board, the other side is unetched copper to serve as a ground-plane. Earth connections are made by hollow rivets. Additionally copper straps are used under the emitters and at the input and output to provide direct contact between the copper on the component side and the ground-plane.

UHF linear power transistor

BLW98

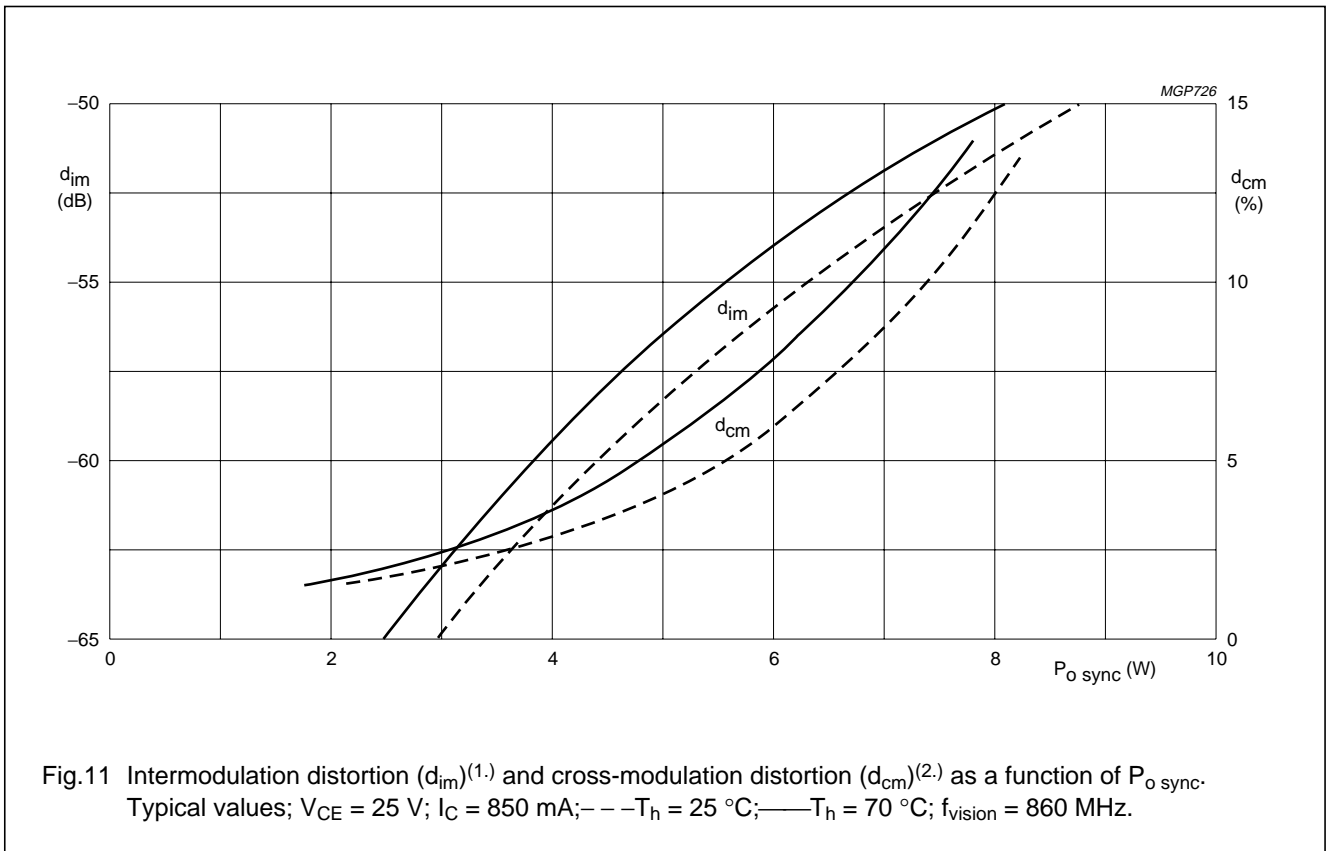
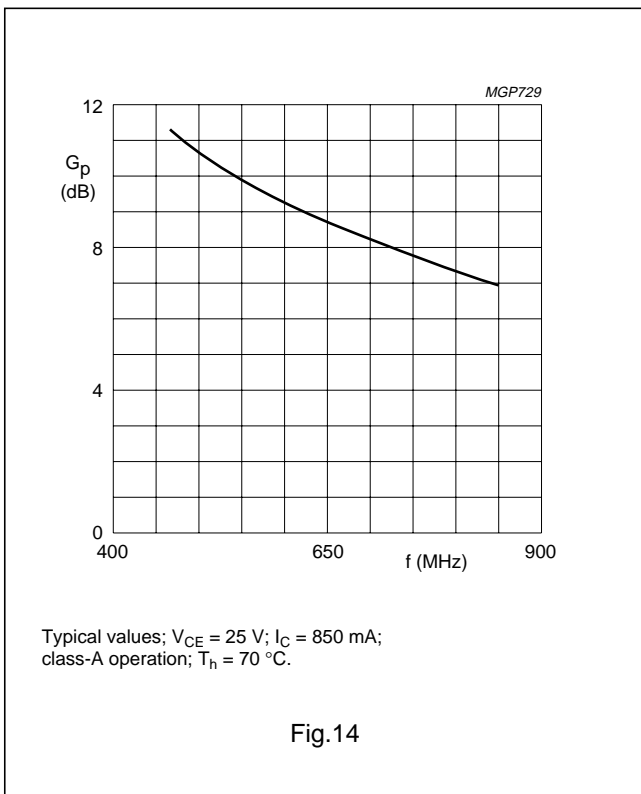
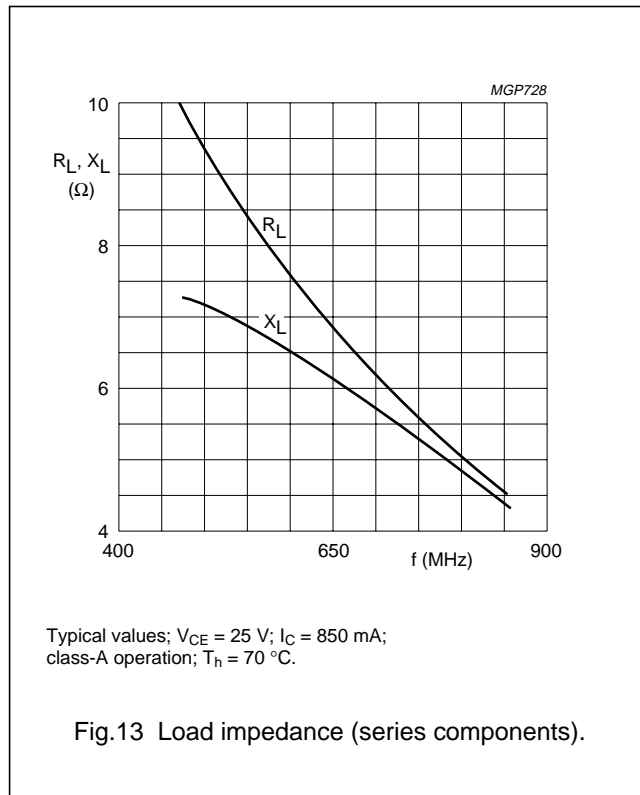
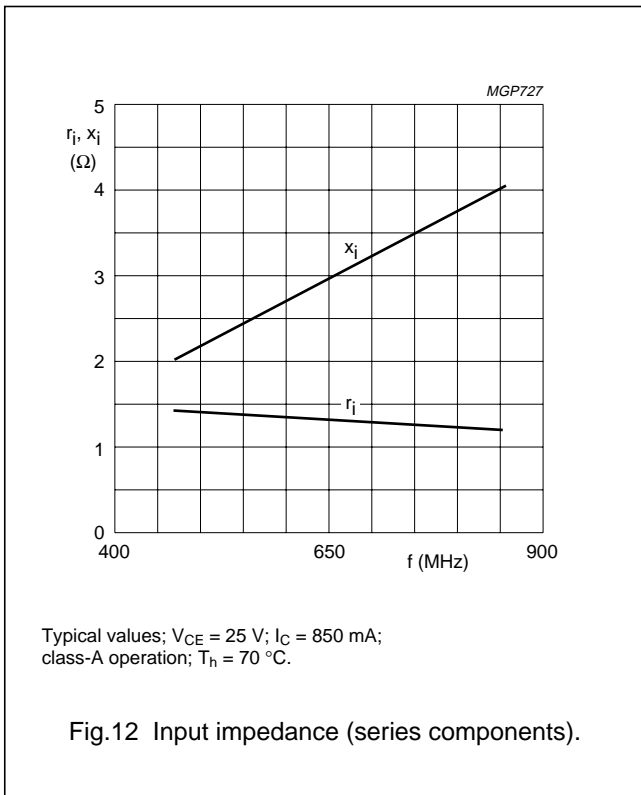

Fig.11 Intermodulation distortion (d_{im})^(1.) and cross-modulation distortion (d_{cm})^(2.) as a function of $P_{o\ sync}$. Typical values; $V_{CE} = 25\text{ V}$; $I_C = 850\text{ mA}$; --- $T_h = 25\text{ }^\circ\text{C}$; — $T_h = 70\text{ }^\circ\text{C}$; $f_{vision} = 860\text{ MHz}$.

1. Three-tone test method (vision carrier -8 dB, sound carrier -7 dB, sideband signal -16 dB), zero dB corresponds to peak sync level.
Intermodulation distortion of input signal $\leq -75\text{ dB}$.
2. Two-tone test method (vision carrier 0 dB, sound carrier -7 dB), zero dB corresponds to peak sync level.
Cross-modulation distortion (d_{cm}) is the voltage variation (%) of sound carrier when vision carrier is switched from 0 dB to -20 dB.

UHF linear power transistor

BLW98



UHF linear power transistor

BLW98

PACKAGE OUTLINE

Studded ceramic package; 4 leads

SOT122A

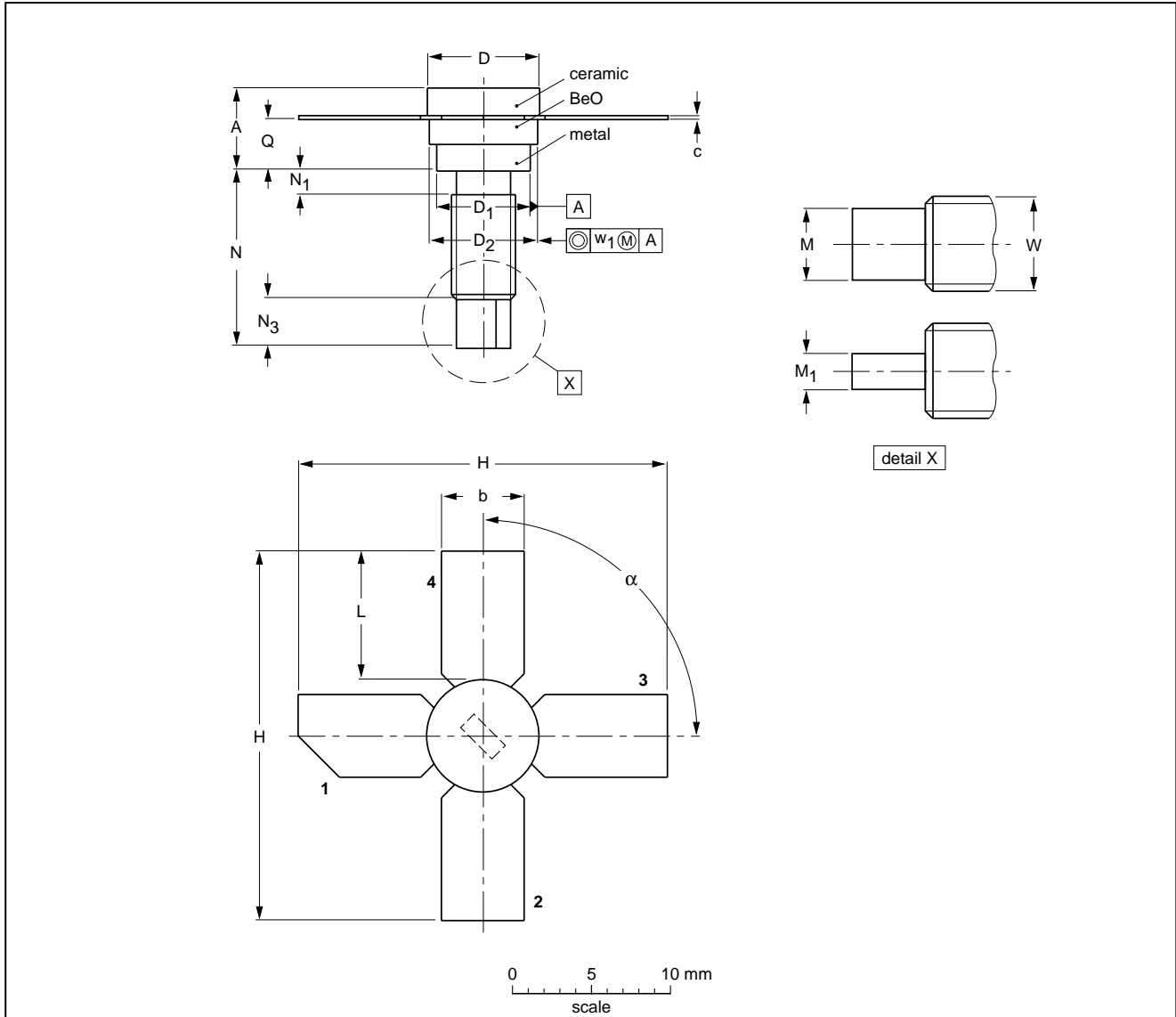

DIMENSIONS (millimetre dimensions are derived from the original inch dimensions)

UNIT	A	b	c	D	D ₁	D ₂	H	L	M ₁	M	N	N ₁ max.	N ₃	Q	W	w ₁	α
mm	5.97 4.74	5.85 5.58	0.18 0.14	7.50 7.23	6.48 6.22	7.24 6.93	27.56 25.78	9.91 9.14	3.18 2.66	1.66 1.39	11.82 11.04	1.02	3.86 2.92	3.38 2.74	8-32 UNC	0.381	90°

OUTLINE VERSION	REFERENCES				EUROPEAN PROJECTION	ISSUE DATE
	IEC	JEDEC	EIAJ			
SOT122A						97-04-18

UHF linear power transistor

BLW98

DEFINITIONS

Data Sheet Status	
Objective specification	This data sheet contains target or goal specifications for product development.
Preliminary specification	This data sheet contains preliminary data; supplementary data may be published later.
Product specification	This data sheet contains final product specifications.
Limiting values	
Limiting values given are in accordance with the Absolute Maximum Rating System (IEC 134). Stress above one or more of the limiting values may cause permanent damage to the device. These are stress ratings only and operation of the device at these or at any other conditions above those given in the Characteristics sections of the specification is not implied. Exposure to limiting values for extended periods may affect device reliability.	
Application information	
Where application information is given, it is advisory and does not form part of the specification.	

LIFE SUPPORT APPLICATIONS

These products are not designed for use in life support appliances, devices, or systems where malfunction of these products can reasonably be expected to result in personal injury. Philips customers using or selling these products for use in such applications do so at their own risk and agree to fully indemnify Philips for any damages resulting from such improper use or sale.