

## **Contents**

Features .....	1
Applications .....	1
Pin Assignment .....	1
Block Diagram .....	2
Selection Guide .....	2
Output Configurations.....	5
Absolute Maximum Ratings .....	6
Electrical Characteristics .....	7
Test Circuits .....	11
Technical Terms .....	12
Standard Circuit.....	13
Operation.....	14
Dimensions.....	16
Taping .....	17
Marking .....	20
Characteristics (typical characteristics).....	21
Application Circuit Examples .....	28
Remarks .....	29
Frequently Asked Questions.....	30

---



---

## SUPER-SMALL PACKAGE HIGH-PRECISION VOLTAGE DETECTOR    S-808 Series

---



---

The S-808 Series is a high-precision voltage detector developed using CMOS process. The detection voltage is fixed internally, with an accuracy of  $\pm 2.0\%$ . Two output types, Nch open-drain and CMOS output, are available.

### ■ Features

- Ultra-low current consumption  
     1.3  $\mu\text{A}$  typ. ( $V_{\text{DD}}=1.5\text{ V}$ )  
     Products with detection voltage of 1.4 V or less electronic  
     0.8  $\mu\text{A}$  typ. ( $V_{\text{DD}}=3.5\text{ V}$ )  
     Products with detection voltage of 1.5, or more
- High-precision detection voltage  
      $\pm 2.0\%$
- Low operating voltage  
     0.7 to 5.0 V  
     Products with detection voltage of 1.4, or less  
     0.95 to 10.0 V  
     Products with a detection voltage of 1.5, or more
- Hysteresis characteristics  
     5% typ.
- Detection voltage  
     0.8 to 6.0 V  
     (0.1 V step)
- Nch open-drain active low and CMOS active low output
- SC-82AB    Super-small plastic package
- TO-92      Plastic package
- SOT-89-3   Miniaturized power mold plastic package
- SOT-23-5   Very-small plastic package

### ■ Applications

- Battery checker
- Power failure detector
- Power monitor for pagers, calculators, organizers,
- Constant voltage power monitor for cameras, video equipment, communication devices
- Power monitor for microcomputers and reset CPUs

### ■ Pin Assignment

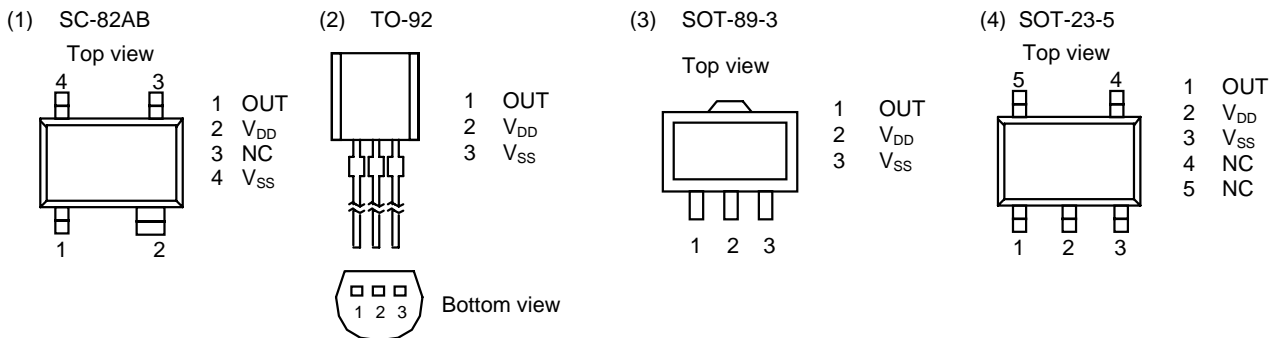

Figure 1

# SUPER-SMALL PACKAGE HIGH-PRECISION VOLTAGE DETECTOR

## S-808 Series

### ■ Block Diagram

(1) Nch open-drain active low output

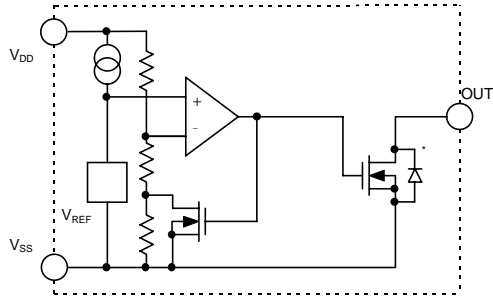

(2) CMOS active low output

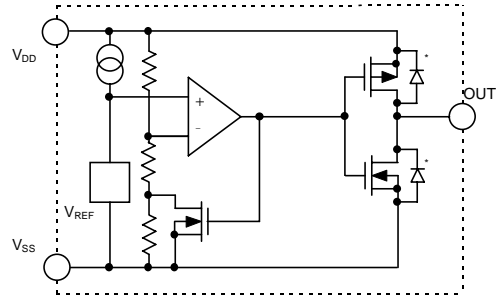

\*Parasitic diode

Figure 2

### ■ Selection Guide

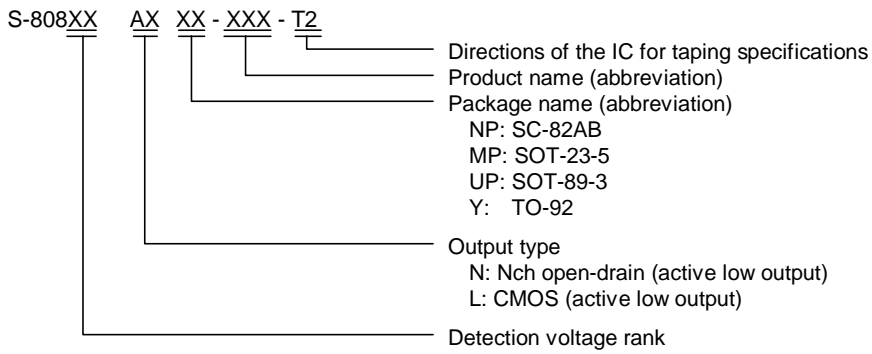

**SUPER-SMALL PACKAGE HIGH-PRECISION VOLTAGE DETECTOR**  
**S-808 Series**

**Table 1**

Detection voltage range (V)	Hysteresis width $V_{HYS}$ typ.(V)	Nch Open Drain(Low)			
		SC-82AB	TO-92	SOT-89-3	SOT-23-5
0.8V±2.0%	0.034	S-80808ANNP-E7Y-T2	—	—	—
0.9V±2.0%	0.044	S-80809ANNP-E7Z-T2	—	—	—
1.0V±2.0%	0.054	S-80810ANNP-E70-T2	—	—	—
1.1V±2.0%	0.064	S-80811ANNP-E71-T2	—	—	—
1.2V±2.0%	0.073	S-80812ANNP-E72-T2	—	—	—
1.3V±2.0%	0.083	S-80813ANNP-EDA-T2	—	—	—
1.4V±2.0%	0.093	S-80814ANNP-EDB-T2	—	—	—
1.5V±2.0%	0.075	S-80815ANNP-EDC-T2	S-80815ANY	S-80815ANUP-EDC-T2	—
1.6V±2.0%	0.080	S-80816ANNP-EDD-T2	S-80816ANY	S-80816ANUP-EDD-T2	—
1.7V±2.0%	0.085	S-80817ANNP-EDE-T2	S-80817ANY	S-80817ANUP-EDE-T2	S-80817ANMP-EDE-T2
1.8V±2.0%	0.090	S-80818ANNP-EDF-T2	S-80818ANY	S-80818ANUP-EDF-T2	S-80818ANMP-EDF-T2
1.9V±2.0%	0.095	S-80819ANNP-EDG-T2	S-80819ANY	S-80819ANUP-EDG-T2	S-80819ANMP-EDG-T2
2.0V±2.0%	0.100	S-80820ANNP-EDH-T2	S-80820ANY	S-80820ANUP-EDH-T2	S-80820ANMP-EDH-T2
2.1V±2.0%	0.105	S-80821ANNP-EDJ-T2	S-80821ANY	S-80821ANUP-EDJ-T2	S-80821ANMP-EDJ-T2
2.2V±2.0%	0.110	S-80822ANNP-EDK-T2	S-80822ANY	S-80822ANUP-EDK-T2	S-80822ANMP-EDK-T2
2.3V±2.0%	0.115	S-80823ANNP-EDL-T2	S-80823ANY	S-80823ANUP-EDL-T2	S-80823ANMP-EDL-T2
2.4V±2.0%	0.120	S-80824ANNP-EDM-T2	S-80824ANY	S-80824ANUP-EDM-T2	S-80824ANMP-EDM-T2
2.5V±2.0%	0.125	S-80825ANNP-EDN-T2	S-80825ANY	S-80825ANUP-EDN-T2	S-80825ANMP-EDN-T2
2.6V±2.0%	0.130	S-80826ANNP-EDP-T2	S-80826ANY	S-80826ANUP-EDP-T2	—
2.7V±2.0%	0.135	S-80827ANNP-EDQ-T2	S-80827ANY	S-80827ANUP-EDQ-T2	S-80827ANMP-EDQ-T2
2.8V±2.0%	0.140	S-80828ANNP-EDR-T2	S-80828ANY	S-80828ANUP-EDR-T2	S-80828ANMP-EDR-T2
2.9V±2.0%	0.145	S-80829ANNP-EDS-T2	S-80829ANY	S-80829ANUP-EDS-T2	—
3.0V±2.0%	0.150	S-80830ANNP-EDT-T2	S-80830ANY	S-80830ANUP-EDT-T2	S-80830ANMP-EDT-T2
3.1V±2.0%	0.155	S-80831ANNP-EDV-T2	S-80831ANY	S-80831ANUP-EDV-T2	—
3.2V±2.0%	0.160	S-80832ANNP-EDW-T2	S-80832ANY	S-80832ANUP-EDW-T2	S-80832ANMP-EDW-T2
3.3V±2.0%	0.165	S-80833ANNP-EDX-T2	S-80833ANY	S-80833ANUP-EDX-T2	S-80833ANMP-EDX-T2
3.4V±2.0%	0.170	S-80834ANNP-EDY-T2	S-80834ANY	S-80834ANUP-EDY-T2	S-80834ANMP-EDY-T2
3.5V±2.0%	0.175	S-80835ANNP-EDZ-T2	S-80835ANY	S-80835ANUP-EDZ-T2	S-80835ANMP-EDZ-T2
3.6V±2.0%	0.180	S-80836ANNP-ED0-T2	S-80836ANY	S-80836ANUP-ED0-T2	S-80836ANMP-ED0-T2
3.7V±2.0%	0.185	S-80837ANNP-ED1-T2	S-80837ANY	S-80837ANUP-ED1-T2	—
3.8V±2.0%	0.190	S-80838ANNP-ED2-T2	S-80838ANY	S-80838ANUP-ED2-T2	—
3.9V±2.0%	0.195	S-80839ANNP-ED3-T2	S-80839ANY	S-80839ANUP-ED3-T2	S-80839ANMP-ED3-T2
4.0V±2.0%	0.200	S-80840ANNP-ED4-T2	S-80840ANY	S-80840ANUP-ED4-T2	S-80840ANMP-ED4-T2
4.1V±2.0%	0.205	S-80841ANNP-ED5-T2	S-80841ANY	S-80841ANUP-ED5-T2	—
4.2V±2.0%	0.210	S-80842ANNP-ED6-T2	S-80842ANY	S-80842ANUP-ED6-T2	S-80842ANMP-ED6-T2
4.3V±2.0%	0.215	S-80843ANNP-ED7-T2	S-80843ANY	S-80843ANUP-ED7-T2	—
4.4V±2.0%	0.220	S-80844ANNP-ED8-T2	S-80844ANY	S-80844ANUP-ED8-T2	S-80844ANMP-ED8-T2
4.5V±2.0%	0.225	S-80845ANNP-ED9-T2	S-80845ANY	S-80845ANUP-ED9-T2	S-80845ANMP-ED9-T2
4.6V±2.0%	0.230	S-80846ANNP-EJA-T2	S-80846ANY	S-80846ANUP-EJA-T2	—
4.7V±2.0%	0.235	S-80847ANNP-EJB-T2	S-80847ANY	S-80847ANUP-EJB-T2	—
4.8V±2.0%	0.240	S-80848ANNP-EJC-T2	S-80848ANY	S-80848ANUP-EJC-T2	—
4.9V±2.0%	0.245	S-80849ANNP-EJD-T2	S-80849ANY	S-80849ANUP-EJD-T2	—
5.0V±2.0%	0.250	S-80850ANNP-EJE-T2	S-80850ANY	S-80850ANUP-EJE-T2	S-80850ANMP-EJE-T2
5.1V±2.0%	0.255	S-80851ANNP-EJF-T2	S-80851ANY	S-80851ANUP-EJF-T2	S-80851ANMP-EJF-T2
5.2V±2.0%	0.260	S-80852ANNP-EJG-T2	—	S-80852ANUP-EJG-T2	—
5.3V±2.0%	0.265	S-80853ANNP-EJH-T2	S-80853ANY	—	—
5.4V±2.0%	0.270	S-80854ANNP-EJJ-T2	—	—	—
5.5V±2.0%	0.275	S-80855ANNP-EJK-T2	—	—	—
5.6V±2.0%	0.280	S-80856ANNP-EJL-T2	—	—	—
5.7V±2.0%	0.285	S-80857ANNP-EJM-T2	—	—	—
5.8V±2.0%	0.290	S-80858ANNP-EJN-T2	—	—	—
5.9V±2.0%	0.295	S-80859ANNP-EJP-T2	—	—	—
6.0V±2.0%	0.300	S-80860ANNP-EJQ-T2	—	S-80860ANUP-EJQ-T2	—

# SUPER-SMALL PACKAGE HIGH-PRECISION VOLTAGE DETECTOR

## S-808 Series

Detection voltage range (V)	Hysteresis width $V_{HYS}$ typ.(V)	CMOS Output Drain(Low)			
		SC-82AB	TO-92	SOT-89-3	SOT-23-5
0.8V±2.0%	0.034	S-80808ALNP-E5Y-T2	—	—	—
0.9V±2.0%	0.044	S-80809ALNP-E5Z-T2	—	—	—
1.0V±2.0%	0.054	S-80810ALNP-E50-T2	—	—	—
1.1V±2.0%	0.064	S-80811ALNP-E51-T2	—	—	—
1.2V±2.0%	0.073	S-80812ALNP-E52-T2	—	—	—
1.3V±2.0%	0.083	S-80813ALNP-EAA-T2	—	—	—
1.4V±2.0%	0.093	S-80814ALNP-EAB-T2	—	—	—
1.5V±2.0%	0.075	S-80815ALNP-EAC-T2	S-80815ALY	S-80815ALUP-EAC-T2	S-80815ALMP-EAC-T2
1.6V±2.0%	0.080	S-80816ALNP-EAD-T2	S-80816ALY	S-80816ALUP-EAD-T2	—
1.7V±2.0%	0.085	S-80817ALNP-EAE-T2	S-80817ALY	S-80817ALUP-EAE-T2	—
1.8V±2.0%	0.090	S-80818ALNP-EAF-T2	S-80818ALY	S-80818ALUP-EAF-T2	S-80818ALMP-EAF-T2
1.9V±2.0%	0.095	S-80819ALNP-EAG-T2	S-80819ALY	S-80819ALUP-EAG-T2	S-80819ALMP-EAG-T2
2.0V±2.0%	0.100	S-80820ALNP-EAH-T2	S-80820ALY	S-80820ALUP-EAH-T2	S-80820ALMP-EAH-T2
2.1V±2.0%	0.105	S-80821ALNP-EAJ-T2	S-80821ALY	S-80821ALUP-EAJ-T2	S-80821ALMP-EAJ-T2
2.2V±2.0%	0.110	S-80822ALNP-EAK-T2	S-80822ALY	S-80822ALUP-EAK-T2	—
2.3V±2.0%	0.115	S-80823ALNP-EAL-T2	S-80823ALY	S-80823ALUP-EAL-T2	S-80823ALMP-EAL-T2
2.4V±2.0%	0.120	S-80824ALNP-EAM-T2	S-80824ALY	S-80824ALUP-EAM-T2	—
2.5V±2.0%	0.125	S-80825ALNP-EAN-T2	S-80825ALY	S-80825ALUP-EAN-T2	S-80825ALMP-EAN-T2
2.6V±2.0%	0.130	S-80826ALNP-EAP-T2	S-80826ALY	S-80826ALUP-EAP-T2	—
2.7V±2.0%	0.135	S-80827ALNP-EAQ-T2	S-80827ALY	S-80827ALUP-EAQ-T2	S-80827ALMP-EAQ-T2
2.8V±2.0%	0.140	S-80828ALNP-EAR-T2	S-80828ALY	S-80828ALUP-EAR-T2	S-80828ALMP-EAR-T2
2.9V±2.0%	0.145	S-80829ALNP-EAS-T2	S-80829ALY	S-80829ALUP-EAS-T2	—
3.0V±2.0%	0.150	S-80830ALNP-EAT-T2	S-80830ALY	S-80830ALUP-EAT-T2	S-80830ALMP-EAT-T2
3.1V±2.0%	0.155	S-80831ALNP-EAV-T2	S-80831ALY	S-80831ALUP-EAV-T2	—
3.2V±2.0%	0.160	S-80832ALNP-EAW-T2	S-80832ALY	S-80832ALUP-EAW-T2	S-80832ALMP-EAW-T2
3.3V±2.0%	0.165	S-80833ALNP-EAX-T2	S-80833ALY	S-80833ALUP-EAX-T2	S-80833ALMP-EAX-T2
3.4V±2.0%	0.170	S-80834ALNP-EAY-T2	S-80834ALY	S-80834ALUP-EAY-T2	—
3.5V±2.0%	0.175	S-80835ALNP-EAZ-T2	S-80835ALY	S-80835ALUP-EAZ-T2	S-80835ALMP-EAZ-T2
3.6V±2.0%	0.180	S-80836ALNP-EA0-T2	S-80836ALY	S-80836ALUP-EA0-T2	—
3.7V±2.0%	0.185	S-80837ALNP-EA1-T2	S-80837ALY	S-80837ALUP-EA1-T2	—
3.8V±2.0%	0.190	S-80838ALNP-EA2-T2	S-80838ALY	S-80838ALUP-EA2-T2	—
3.9V±2.0%	0.195	S-80839ALNP-EA3-T2	S-80839ALY	S-80839ALUP-EA3-T2	—
4.0V±2.0%	0.200	S-80840ALNP-EA4-T2	S-80840ALY	S-80840ALUP-EA4-T2	S-80840ALMP-EA4-T2
4.1V±2.0%	0.205	S-80841ALNP-EA5-T2	S-80841ALY	S-80841ALUP-EA5-T2	—
4.2V±2.0%	0.210	S-80842ALNP-EA6-T2	S-80842ALY	S-80842ALUP-EA6-T2	S-80842ALMP-EA6-T2
4.3V±2.0%	0.215	S-80843ALNP-EA7-T2	S-80843ALY	S-80843ALUP-EA7-T2	—
4.4V±2.0%	0.220	S-80844ALNP-EA8-T2	S-80844ALY	S-80844ALUP-EA8-T2	—
4.5V±2.0%	0.225	S-80845ALNP-EA9-T2	S-80845ALY	S-80845ALUP-EA9-T2	S-80845ALMP-EA9-T2
4.6V±2.0%	0.230	S-80846ALNP-EEA-T2	S-80846ALY	S-80846ALUP-EEA-T2	—
4.7V±2.0%	0.235	S-80847ALNP-EEB-T2	S-80847ALY	S-80847ALUP-EEB-T2	—
4.8V±2.0%	0.240	S-80848ALNP-EEC-T2	S-80848ALY	S-80848ALUP-EEC-T2	—
4.9V±2.0%	0.245	S-80849ALNP-EED-T2	S-80849ALY	S-80849ALUP-EED-T2	S-80849ALMP-EED-T2
5.0V±2.0%	0.250	S-80850ALNP-EEE-T2	S-80850ALY	S-80850ALUP-EEE-T2	S-80850ALMP-EEE-T2
5.1V±2.0%	0.255	S-80851ALNP-EEF-T2	S-80851ALY	S-80851ALUP-EEF-T2	S-80851ALMP-EEF-T2
5.2V±2.0%	0.260	S-80852ALNP-EEG-T2	—	S-80852ALUP-EEG-T2	S-80852ALMP-EEG-T2
5.3V±2.0%	0.265	S-80853ALNP-EEH-T2	—	—	—
5.4V±2.0%	0.270	S-80854ALNP-EEJ-T2	—	—	—
5.5V±2.0%	0.275	S-80855ALNP-EEK-T2	—	S-80855ALUP-EEK-T2	—
5.6V±2.0%	0.280	S-80856ALNP-EEL-T2	—	—	—
5.7V±2.0%	0.285	S-80857ALNP-EEM-T2	—	—	—
5.8V±2.0%	0.290	S-80858ALNP-EEN-T2	—	—	—
5.9V±2.0%	0.295	S-80859ALNP-EEP-T2	—	—	—
6.0V±2.0%	0.300	S-80860ALNP-EEQ-T2	—	—	—

Remark: Some products described here in are under development. Please contact us for Samples.

■ **Output Configurations**

1. S-808 Series model numbering system

	Nch open-drain ("L" reset type)	CMOS output ("L" reset type)
S-808 Series	"N" is the last letter of the model number. e.g. S-80808AN	"L" is the last letter of the model number. e.g. S-80808AL

2. Output configurations and their implementation

Implementation	Nch("L")	CMOS("L")
With different power supplies	Yes	No
With active low reset CPUs	Yes	Yes
With active high reset CPUs	No	No
With voltage divider variable resistors	Yes	No

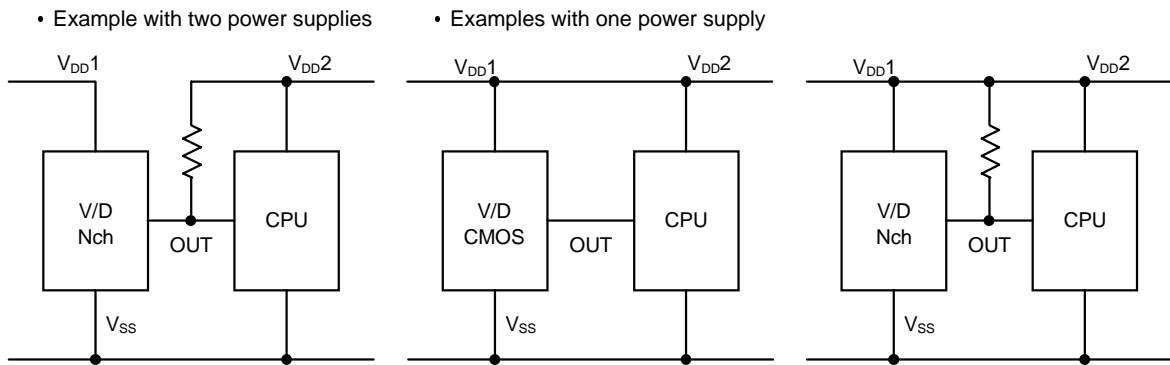

Figure 3

# SUPER-SMALL PACKAGE HIGH-PRECISION VOLTAGE DETECTOR

## S-808 Series

### ■ Absolute Maximum Ratings

1. Products with detection voltage of 1.4 V or less

(Unless otherwise specified: Ta=25°C)

Parameter		Symbol	Ratings	Unit
Power supply voltage		$V_{DD} - V_{SS}$	7	V
Output voltage	Nch open-drain	$V_{OUT}$	$V_{SS}-0.3$ to 7	V
	CMOS		$V_{SS}-0.3$ to $V_{DD}+0.3$	V
Output current		$I_{OUT}$	50	mA
Power dissipation		$P_d$	150	mW
Operating temperature		$T_{opr}$	-20 to +70	°C
Storage temperature		$T_{stg}$	-40 to +125	°C

2. Products with detection voltage of 1.5 V or more

(Unless otherwise specified: Ta=25°C)

Parameter		Symbol	Ratings	Unit
Power supply voltage		$V_{DD} - V_{SS}$	12	V
Output voltage	Nch open-drain	$V_{OUT}$	$V_{SS}-0.3$ to 12	V
	CMOS		$V_{SS}-0.3$ to $V_{DD}+0.3$	V
Output current		$I_{OUT}$	50	mA
Power dissipation	$P_d$	TO-92	400	mW
		SOT-89-3	500	
		SC-82AB,SOT-23-5	150	
Operating temperature		$T_{opr}$	-40 to +85	°C
Storage temperature		$T_{stg}$	-40 to +125	°C

Remark: This IC has a built-in protection circuit for static electricity. However, prevent contact with a large static electricity or electrostatic voltage which exceeds the performance of the protection circuit

**SUPER-SMALL PACKAGE HIGH-PRECISION VOLTAGE DETECTOR**  
**S-808 Series**

■ **Electrical Characteristics**

1. Detection voltage (0.8 V to 1.4 V)

(Unless otherwise specified: Ta=25°C)

Parameter	Symbol	Conditions	Min.	Typ.	Max.	Unit	Test circuit	
Detection voltage	-V <sub>DET</sub>	S-80808AX	0.784	0.800	0.816	V	1	
		S-80809AX	0.882	0.900	0.918			
		S-80810AX	0.980	1.000	1.020			
		S-80811AX	1.078	1.100	1.122			
		S-80812AX	1.176	1.200	1.224			
		S-80813AX	1.274	1.300	1.326			
		S-80814AX	1.372	1.400	1.428			
Release voltage	+V <sub>DET</sub>	S-80808AX	0.802	0.834	0.867	V	1	
		S-80809AX	0.910	0.944	0.979			
		S-80810AX	1.017	1.054	1.091			
		S-80811AX	1.125	1.164	1.203			
		S-80812AX	1.232	1.273	1.315			
		S-80813AX	1.340	1.383	1.427			
		S-80814AX	1.448	1.493	1.538			
Hysteresis width	V <sub>HYS</sub>	S-80808AX	0.018	0.034	0.051	V	1	
		S-80809AX	0.028	0.044	0.061			
		S-80810AX	0.037	0.054	0.071			
		S-80811AX	0.047	0.064	0.081			
		S-80812AX	0.056	0.073	0.091			
		S-80813AX	0.066	0.083	0.101			
		S-80814AX	0.076	0.093	0.110			
Current consumption	I <sub>SS</sub>	V <sub>DD</sub> =1.5V	S-80808AX	—	1.3	3.7	μA	2
			S-80809AX					
			S-80810AX					
		V <sub>DD</sub> =2.0V	S-80811AX					
			S-80812AX					
			S-80813AX					
			S-80814AX					
Operating voltage	V <sub>DD</sub>		0.7	—	5.0	V	1	
Output current	I <sub>OUT</sub>	Nch	V <sub>DS</sub> =0.5V	0.04	0.2	—	mA	3
			V <sub>DD</sub> =0.7V					
		Pch(CMOS output)	V <sub>DS</sub> =2.1V	2.9	5.8	—		4
			V <sub>DD</sub> =4.5V					
Leakage current of output transistor	I <sub>LEAK</sub>	Nch(Nch open drain)	V <sub>DS</sub> =5.0V	—	—	60	nA	3
Temperature characteristic of -V <sub>DET</sub>	Δ-V <sub>DET</sub> ΔTa	Ta=-20°C to +70°C	S-80808AX	—	±0.18	—	mV/°C	1
			S-80809AX	—	±0.20	—		
			S-80810AX	—	±0.22	—		
			S-80811AX	—	±0.24	—		
			S-80812AX	—	±0.27	—		
			S-80813AX	—	±0.29	—		
			S-80814AX	—	±0.31	—		



# SUPER-SMALL PACKAGE HIGH-PRECISION VOLTAGE DETECTOR

## S-808 Series

### 2. Detection voltage (1.5 V to 2.6 V)

(Unless otherwise specified: Ta=25°C)

Parameter	Symbol	Conditions	Min.	Typ.	Max.	Unit	Test circuit	
Detection voltage	-V <sub>DET</sub>	S-80815AX	1.470	1.500	1.530	V	1	
		S-80816AX	1.568	1.600	1.632			
		S-80817AX	1.666	1.700	1.734			
		S-80818AX	1.764	1.800	1.836			
		S-80819AX	1.862	1.900	1.938			
		S-80820AX	1.960	2.000	2.040			
		S-80821AX	2.058	2.100	2.142			
		S-80822AX	2.156	2.200	2.244			
		S-80823AX	2.254	2.300	2.346			
		S-80824AX	2.352	2.400	2.448			
		S-80825AX	2.450	2.500	2.550			
S-80826AX	2.548	2.600	2.652					
Hysteresis width	V <sub>HYS</sub>		-V <sub>DET</sub> ×0.03	-V <sub>DET</sub> ×0.05	-V <sub>DET</sub> ×0.08	V	1	
Current consumption	I <sub>SS</sub>	V <sub>DD</sub> =3.5V	—	0.8	2.4	μA	2	
Operating voltage	V <sub>DD</sub>		0.95	—	10.0	V	1	
Output current	I <sub>OUT</sub>	Nch V <sub>DS</sub> =0.5V V <sub>DD</sub> =1.2V	0.23	0.50	—	mA	3	
		Pch(CMOS output) V <sub>DS</sub> =0.5V V <sub>DD</sub> =4.8V	0.36	0.62	—		4	
Leakage current of output transistor	I <sub>LEAK</sub>	Nch(Nch open drain) V <sub>DS</sub> =10.0 V V <sub>DD</sub> =10.0 V	—	—	0.1	μA	3	
Response time	t <sub>PLH</sub>		—	—	60	μs	1	
Temperature characteristic of -V <sub>DET</sub>	Δ-V <sub>DET</sub> ΔT <sub>a</sub>	Ta=-40°C to +85°C	S-80815AX	—	±0.18	±0.54	mV/°C	1
			S-80816AX	—	±0.19	±0.57		
			S-80817AX	—	±0.20	±0.60		
			S-80818AX	—	±0.21	±0.63		
			S-80819AX	—	±0.22	±0.66		
			S-80820AX	—	±0.24	±0.72		
			S-80821AX	—	±0.25	±0.75		
			S-80822AX	—	±0.26	±0.78		
			S-80823AX	—	±0.27	±0.81		
			S-80824AX	—	±0.28	±0.84		
			S-80825AX	—	±0.29	±0.87		
S-80826AX	—	±0.31	±0.93					

**SUPER-SMALL PACKAGE HIGH-PRECISION VOLTAGE DETECTOR**  
**S-808 Series**

3. Detection voltage (2.7 V to 3.9 V)

(Unless otherwise specified: Ta=25°C)

Parameter	Symbol	Conditions	Min.	Typ.	Max.	Unit	Test circuit	
Detection voltage	$-V_{DET}$	S-80827AX	2.646	2.700	2.754	V	1	
		S-80828AX	2.744	2.800	2.856			
		S-80829AX	2.842	2.900	2.958			
		S-80830AX	2.940	3.000	3.060			
		S-80831AX	3.038	3.100	3.162			
		S-80832AX	3.136	3.200	3.264			
		S-80833AX	3.234	3.300	3.366			
		S-80834AX	3.332	3.400	3.468			
		S-80835AX	3.430	3.500	3.570			
		S-80836AX	3.528	3.600	3.672			
		S-80837AX	3.626	3.700	3.774			
		S-80838AX	3.724	3.800	3.876			
S-80839AX	3.822	3.900	3.978					
Hysteresis width	$V_{HYS}$		$-V_{DET}$ 0.03	$-V_{DET}$ $\times 0.05$	$-V_{DET}$ $\times 0.08$	V	1	
Current consumption	$I_{SS}$	$V_{DD}=4.5V$	—	0.9	2.7	$\mu A$	2	
Operating voltage	$V_{DD}$		0.95	—	10.0	V	1	
Output current	$I_{OUT}$	Nch $V_{DS}=0.5V$	$V_{DD}=1.2V$ 0.23	0.50	—	mA	3	
			$V_{DD}=2.4V$ 1.60	3.70	—			
		Pch(CMOS output) $V_{DS}=0.5V$	$V_{DD}=4.8V$ 0.36	0.62	—		4	
Leakage current of output transistor	$I_{LEAK}$	Nch(Nch open drain) $V_{DS}=10.0V$ $V_{DD}=10.0V$	—	—	0.1	$\mu A$	3	
Response time	tPLH		—	—	60	$\mu s$	1	
Temperature characteristic of $-V_{DET}$	$\frac{\Delta -V_{DET}}{\Delta T_a}$	Ta=-40°C to +85°C	S-80827AX	—	$\pm 0.32$	$\pm 0.96$	mV/°C	1
			S-80828AX	—	$\pm 0.33$	$\pm 0.99$		
			S-80829AX	—	$\pm 0.34$	$\pm 1.02$		
			S-80830AX	—	$\pm 0.35$	$\pm 1.05$		
			S-80831AX	—	$\pm 0.36$	$\pm 1.08$		
			S-80832AX	—	$\pm 0.38$	$\pm 1.14$		
			S-80833AX	—	$\pm 0.39$	$\pm 1.17$		
			S-80834AX	—	$\pm 0.40$	$\pm 1.20$		
			S-80835AX	—	$\pm 0.41$	$\pm 1.23$		
			S-80836AX	—	$\pm 0.42$	$\pm 1.26$		
			S-80837AX	—	$\pm 0.44$	$\pm 1.32$		
			S-80838AX	—	$\pm 0.45$	$\pm 1.35$		
S-80839AX	—	$\pm 0.46$	$\pm 1.38$					

# SUPER-SMALL PACKAGE HIGH-PRECISION VOLTAGE DETECTOR

## S-808 Series

### 4. Detection voltage (4.0 V to 5.6 V)

(Unless otherwise specified: Ta=25°C)

Parameter	Symbol	Conditions	Min.	Typ.	Max.	Unit	Test circuit	
Detection voltage	-V <sub>DET</sub>	S-80840AX	3.920	4.000	4.080	V	1	
		S-80841AX	4.018	4.100	4.182			
		S-80842AX	4.116	4.200	4.284			
		S-80843AX	4.214	4.300	4.386			
		S-80844AX	4.312	4.400	4.488			
		S-80845AX	4.410	4.500	4.590			
		S-80846AX	4.508	4.600	4.692			
		S-80847AX	4.606	4.700	4.794			
		S-80848AX	4.704	4.800	4.896			
		S-80849AX	4.802	4.900	4.998			
		S-80850AX	4.900	5.000	5.100			
		S-80851AX	4.998	5.100	5.202			
		S-80852AX	5.096	5.200	5.304			
		S-80853AX	5.194	5.300	5.406			
		S-80854AX	5.292	5.400	5.508			
S-80855AX	5.390	5.500	5.610					
S-80856AX	5.488	5.600	5.712					
Hysteresis width	V <sub>HYS</sub>		-V <sub>DET</sub> ×0.03	-V <sub>DET</sub> ×0.05	-V <sub>DET</sub> ×0.08	V	1	
Current consumption	I <sub>SS</sub>	V <sub>DD</sub> =6.0V	—	1.0	3.0	μA	2	
Operating voltage	V <sub>DD</sub>		0.95	—	10.0	V	1	
Output current	I <sub>OUT</sub>	Nch V <sub>DS</sub> =0.5V	V <sub>DD</sub> =1.2V 0.23	0.50	—	mA	3	
			V <sub>DD</sub> =2.4V 1.60	3.70	—			
		Pch(CMOS output) V <sub>DS</sub> =0.5V	V <sub>DD</sub> =6.0V 0.46	0.75	—		4	
Leakage current of output transistor	I <sub>LEAK</sub>	Nch(Nch open drain) V <sub>DS</sub> =10.0 V V <sub>DD</sub> =10.0 V	—	—	0.1	μA	3	
Response time	tPLH		—	—	60	μs	1	
Temperature characteristic of -V <sub>DET</sub>	$\frac{\Delta-V_{DET}}{\Delta T_a}$	Ta=-40°C to +85°C	S-80840AX	—	±0.47	±1.41	mV/°C	1
			S-80841AX	—	±0.48	±1.44		
			S-80842AX	—	±0.49	±1.47		
			S-80843AX	—	±0.51	±1.53		
			S-80844AX	—	±0.52	±1.56		
			S-80845AX	—	±0.53	±1.59		
			S-80846AX	—	±0.54	±1.62		
			S-80847AX	—	±0.55	±1.65		
			S-80848AX	—	±0.56	±1.68		
			S-80849AX	—	±0.58	±1.74		
			S-80850AX	—	±0.59	±1.77		
			S-80851AX	—	±0.60	±1.80		
			S-80852AX	—	±0.61	±1.83		
			S-80853AX	—	±0.62	±1.86		
			S-80854AX	—	±0.64	±1.92		
S-80855AX	—	±0.65	±1.95					
S-80856AX	—	±0.66	±1.98					

# SUPER-SMALL PACKAGE HIGH-PRECISION VOLTAGE DETECTOR S-808 Series

## 5. Detection voltage (5.7 V to 6.0 V)

(Unless otherwise specified:  $T_a=25^\circ\text{C}$ )

Parameter	Symbol	Conditions	Min.	Typ.	Max.	Unit	Test circuit	
Detection voltage	$-V_{\text{DET}}$	S-80857AX	5.586	5.700	5.814	V	1	
		S-80858AX	5.684	5.800	5.916			
		S-80859AX	5.782	5.900	6.018			
		S-80860AX	5.880	6.000	6.120			
Hysteresis width	$V_{\text{HYS}}$		$-V_{\text{DET}} \times 0.03$	$-V_{\text{DET}} \times 0.05$	$-V_{\text{DET}} \times 0.08$	V	1	
Current consumption	$I_{\text{SS}}$	$V_{\text{DD}}=7.5\text{V}$	—	1.0	3.0	$\mu\text{A}$	2	
Operating voltage	$V_{\text{DD}}$		0.95	—	10.0	V	1	
Output current	$I_{\text{OUT}}$	Nch $V_{\text{DS}}=0.5\text{V}$	$V_{\text{DD}}=1.2\text{V}$	0.23	0.50	—	mA	3
			$V_{\text{DD}}=2.4\text{V}$	1.60	3.70	—		
		Pch(CMOS output) $V_{\text{DS}}=0.5\text{V}$	$V_{\text{DD}}=8.4\text{V}$	0.59	0.96	—		4
Leakage current of output transistor	$I_{\text{LEAK}}$	Nch(Nch open drain) $V_{\text{DS}}=10.0\text{V}$ $V_{\text{DD}}=10.0\text{V}$	—	—	0.1	$\mu\text{A}$	3	
Response time	$t_{\text{PLH}}$		—	—	60	$\mu\text{s}$	1	
Temperature characteristic of $-V_{\text{DET}}$	$\frac{\Delta -V_{\text{DET}}}{\Delta T_a}$	$T_a=-40^\circ\text{C}$ to $+85^\circ\text{C}$	S-80857AX	—	$\pm 0.67$	$\pm 2.01$	mV/ $^\circ\text{C}$	1
			S-80858AX	—	$\pm 0.68$	$\pm 2.04$		
			S-80859AX	—	$\pm 0.69$	$\pm 2.07$		
			S-80860AX	—	$\pm 0.71$	$\pm 2.13$		

### ■ Test Circuits

(1)

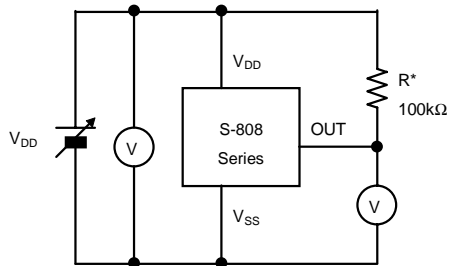

\* R is unnecessary for CMOS output products.

(2)

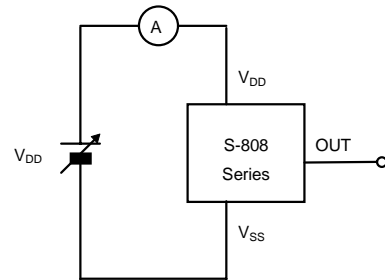

(3)

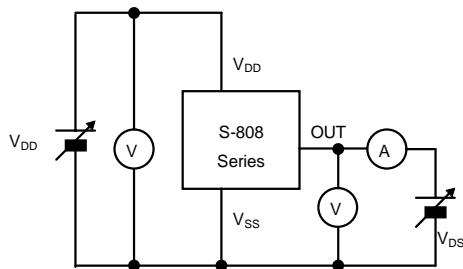

(4)

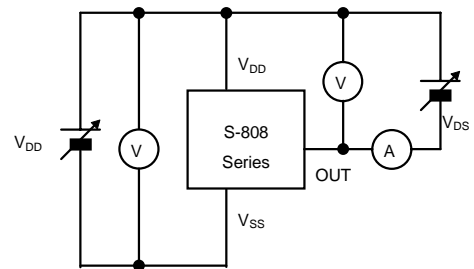

Figure 4

# SUPER-SMALL PACKAGE HIGH-PRECISION VOLTAGE DETECTOR

## S-808 Series

### ■ Technical Terms

#### 1. Detection voltage ( $-V_{DET}$ )

The detection voltage  $-V_{DET}$  is the voltage at which the output switches to low. This detection voltage varies slightly among products of the same type. The variation of voltages between the specified minimum [ $(-V_{DET})_{min.}$ ] and maximum [ $(-V_{DET})_{max.}$ ] values is called the detection voltage range (See Figure 5).

**Example :** For the S-80808AN, detection voltage lies in the range of  $0.784 \leq (-V_{DET}) \leq 0.816$ .

This means that  $-V_{DET}$  is 0.784 in a product while  $-V_{DET}$  is 0.816 in another of the same S-80808AN.

#### 2. Release voltage ( $+V_{DET}$ )

The release voltage  $+V_{DET}$  is the voltage at which the output returns (is “released”) to high. This release voltage varies slightly among products of the same type. The variation of voltages between the specified minimum [ $(+V_{DET})_{min.}$ ] and maximum [ $(+V_{DET})_{max.}$ ] values is called the release voltage range (See Figure 6).

**Example :** For the S-80808AN, the release voltage lies in the range of  $0.802 \leq (+V_{DET}) \leq 0.867$ . This means that  $+V_{DET}$  is 0.802 in a product while  $+V_{DET}$  is 0.867 in another of the same S-80808AN.

**Remark:** Although the detection voltage and release voltage overlap in the range of 0.802 V to 0.816 V,  $+V_{DET}$  will always be larger than  $-V_{DET}$ .

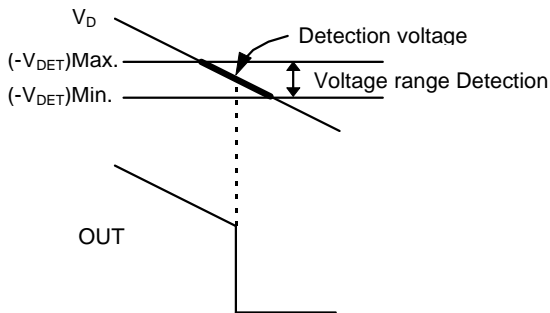

Figure 5

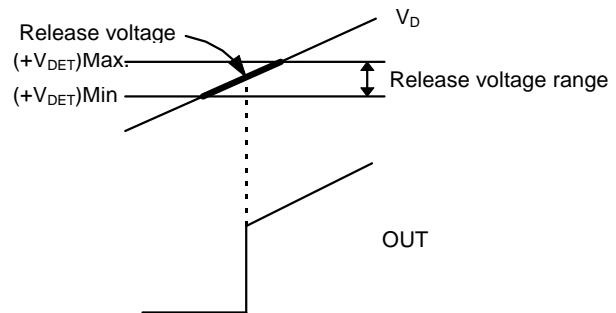

Figure 6

#### 3. Hysteresis width ( $V_{HYS}$ )

The hysteresis width is the voltage difference between the detection voltage and the release voltage ( $B-A=V_{HYS}$  in Figure 10). By giving a device hysteresis, trouble such as noise at the input is avoided.

#### 4. Through-type current

Through-type current refers to the current which flows instantaneously at the time of detection and release of a voltage detector. Through-type current is large in CMOS output devices, and also flows to some extent in Nch open-drain output devices.

5. Oscillation

In applications where a resistor is connected to the voltage detector input (Figure 7), in the CMOS active low products for example, the through-type current generated when the output goes from low to high (release) causes a voltage drop equal to [through-type current]×[input resistance] across the resistor. When the resultant input voltage drops below the detection voltage  $-V_{DET}$ , the output voltage returns to its low level. In this state, the through-type current and its resultant voltage drop have disappeared, and the output goes back from low to high. A through-type current is again generated, a voltage drop appears, and the process repeats. This unstable condition is referred to as oscillation.

- Misimplementation with input voltage divider

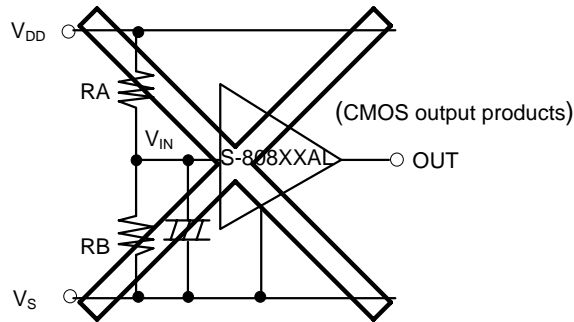
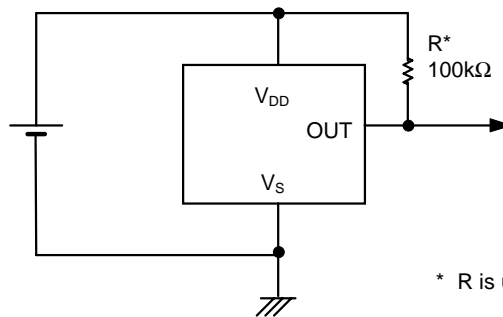

Figure 7

■ Standard Circuit



\* R is unnecessary for\* CMOS output

Figure 8

**SUPER-SMALL PACKAGE HIGH-PRECISION VOLTAGE DETECTOR**  
**S-808 Series**

■ **Operation**

1. Basic operation : CMOS active low output

- (1) When power supply voltage  $V_{DD}$  is greater than the release voltage  $+V_{DET}$ , the Nch transistor is OFF and the Pch transistor ON, causing  $V_{DD}$  (high) to appear at the output. With the Nch transistor N1 of Figure 9 OFF, the comparator input voltage is  $(RB+RC)/(RA+RB+RC) \times V_{DD}$ .
- (2) When power supply voltage  $V_{DD}$  goes below  $+V_{DET}$ , the output maintains the power supply voltage level, as long as  $V_{DD}$  remains above the detection voltage  $-V_{DET}$ . When  $V_{DD}$  does fall below  $-V_{DET}$  (A in Figure 10), the Nch transistor goes ON, the Pch transistor goes OFF, and  $V_{SS}$  appears at the output. With the Nch transistor N 1 of Figure 9 ON, the comparator input voltage is  $RB/(RA+RB) \times V_{DD}$ .
- (3) When  $V_{DD}$  falls below the minimum operating voltage, the output becomes undefined. However, output will revert to  $V_{DD}$  if a pull-up has been employed.
- (4)  $V_{SS}$  will again be output when  $V_{DD}$  rises above the minimum operating voltage.  $V_{SS}$  will continue to be output even when  $V_{DD}$  surpasses  $-V_{DET}$ , as long as it does not exceed the release voltage  $+V_{DET}$ .
- (5) When  $V_{DD}$  rises above  $+V_{DET}$  (B in Figure 10), the Nch transistor goes OFF, the Pch transistor goes ON, and  $V_{DD}$  appears at the output.

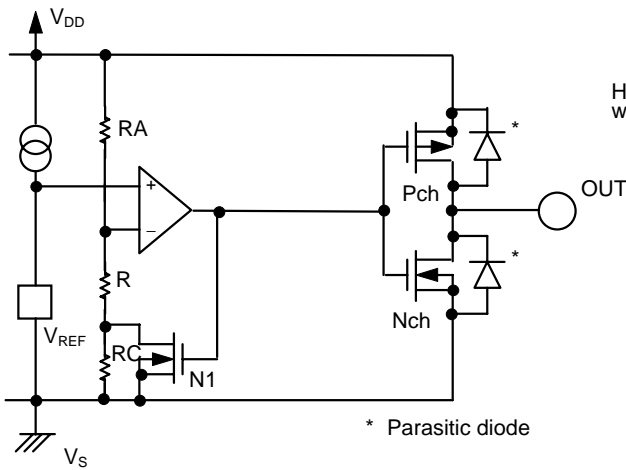

Figure 9

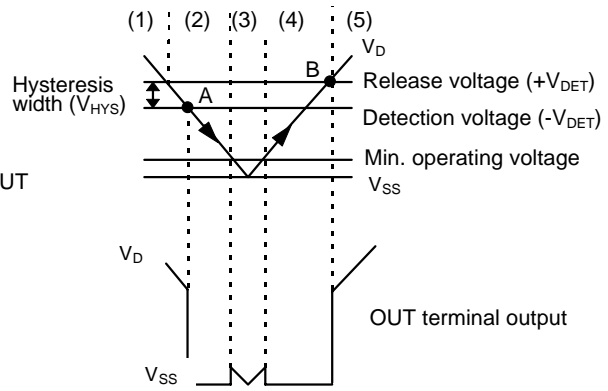

Figure 10

2. Other characteristics

(1) Temperature characteristic of detection voltage

The temperature characteristics of the detection voltage are expressed by the oblique line parts in Figure 11.

S-80815AXNP:

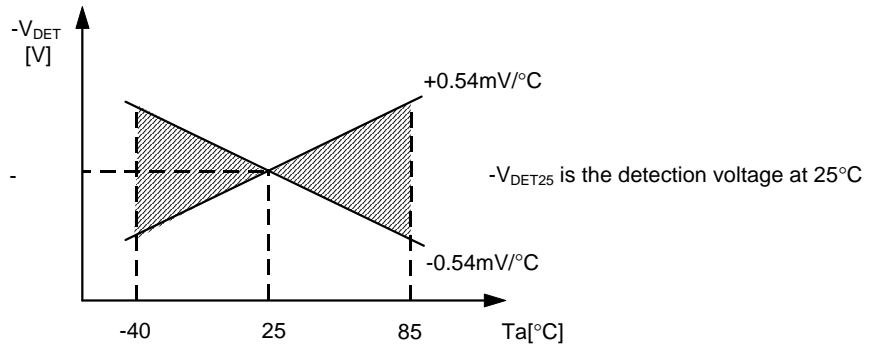

**Figure 11**

(2) Temperature characteristics of release voltage

The temperature factor  $\left(\frac{\Delta+V_{DET}}{\Delta Ta}\right)$  of the release voltage is calculated by the temperature factor of the detection voltage as follows:

$$\frac{\Delta+V_{DET}}{\Delta Ta} = \frac{+V_{DET}}{-V_{DET}} \times \frac{\Delta-V_{DET}}{\Delta Ta}$$

The temperature factor of the release voltage has a same sign characteristics as the temperature factor of the detection voltage.

(3) Temperature characteristics of hysteresis voltage

The temperature characteristics of hysteresis voltage  $\left(\frac{\Delta+V_{DET}}{\Delta Ta} - \frac{\Delta-V_{DET}}{\Delta Ta}\right)$  is calculated as

$$\frac{\Delta+V_{DET}}{\Delta Ta} - \frac{\Delta-V_{DET}}{\Delta Ta} = \frac{V_{HY}}{-V_{DET}} \times \frac{\Delta-V_{DET}}{\Delta Ta}$$

Remark: An example of temperature characteristics of (1) to (3) is shown on pages 21 and 22.



# SUPER-SMALL PACKAGE HIGH-PRECISION VOLTAGE DETECTOR

## S-808 Series

### ■ Dimensions

(1) SC-82AB

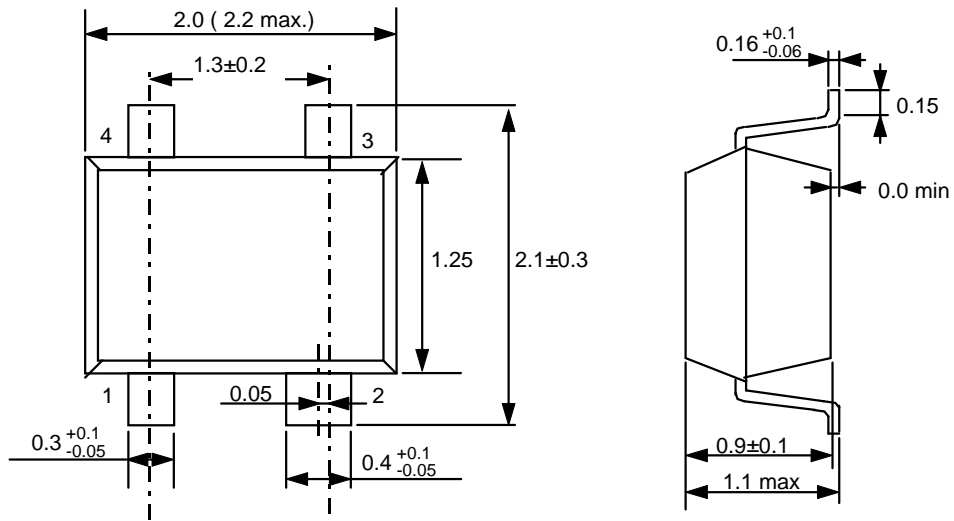

The surface of lead wire is plated or dipped with solder.

(2) TO-92

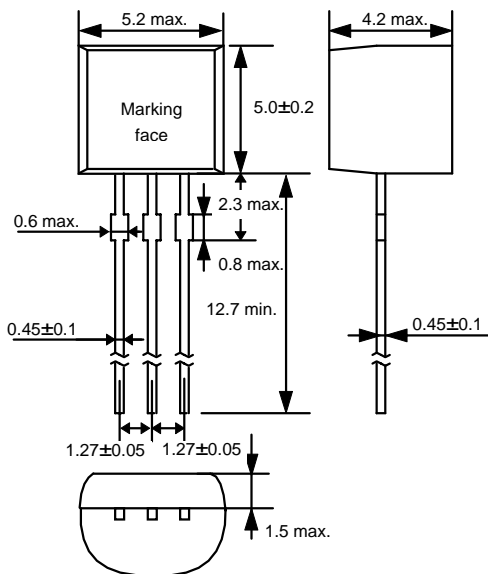

(3) SOT-89-3

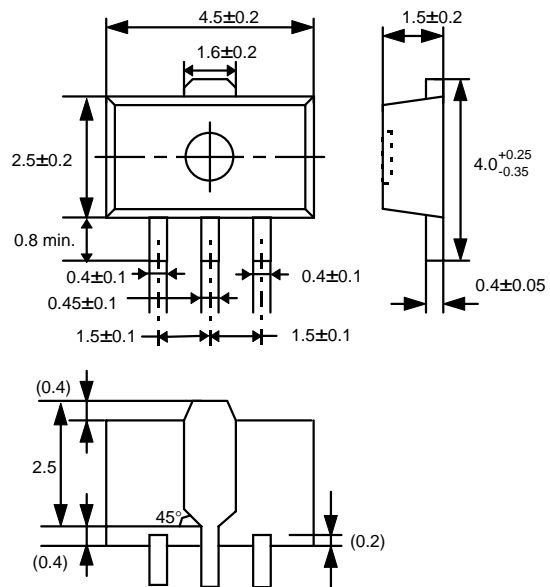

(4) SOT-23-5

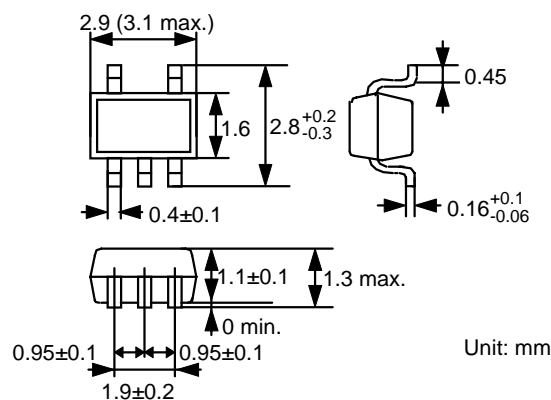

Unit: mm

Figure 12

■ Taping

1.SC-82AB

1.1 Tape specifications

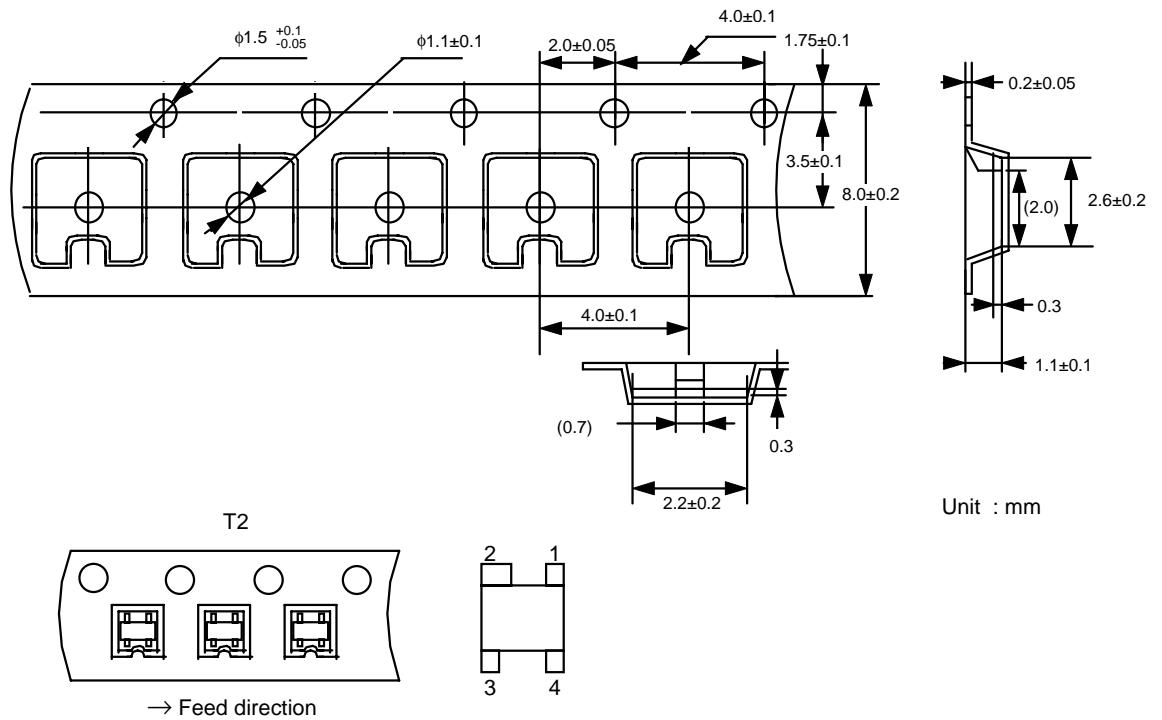

Figure 13

1.2 Reel specifications

1 reel holds 3000 detectors.

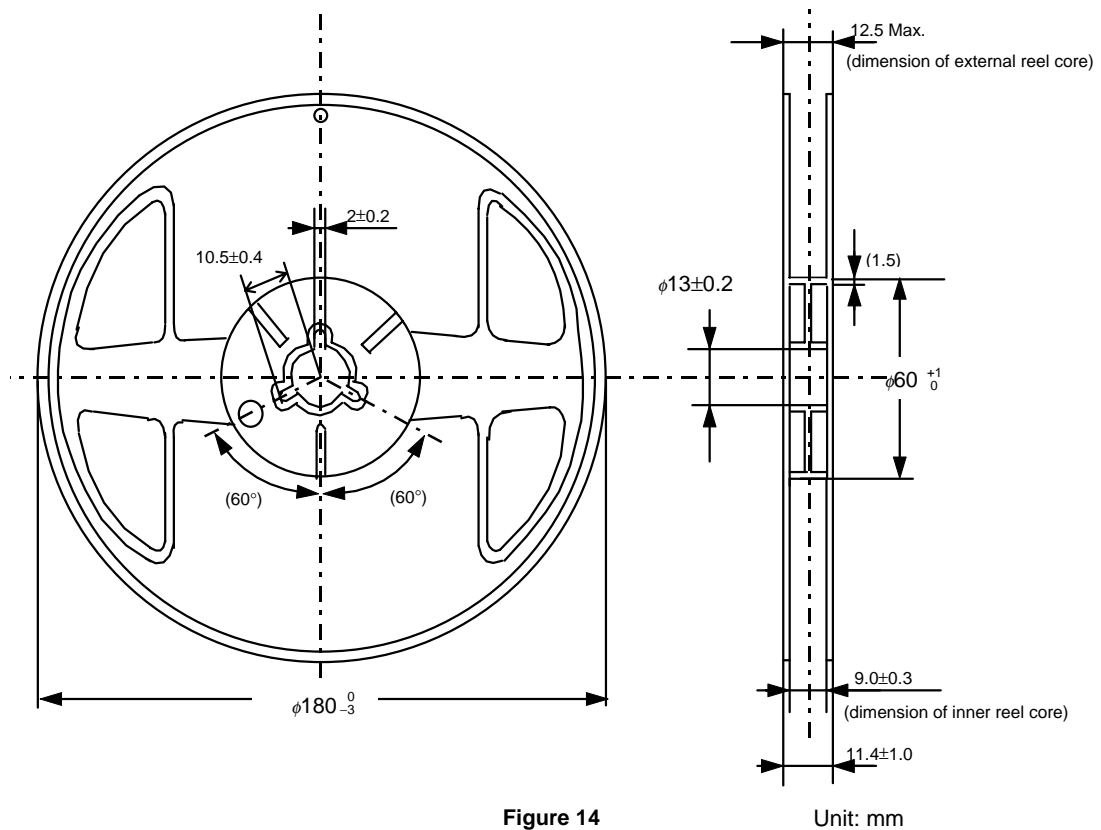

Figure 14

**SUPER-SMALL PACKAGE HIGH-PRECISION VOLTAGE DETECTOR**  
**S-808 Series**

2. SOT-89-3

2.1 Tape specifications

There are two color (white and blue) labels depending upon the presence of holes at center of the emboss.

Two types of tape (T1 and T2) are available depending upon the direction of the IC on the tape.

(1) White label

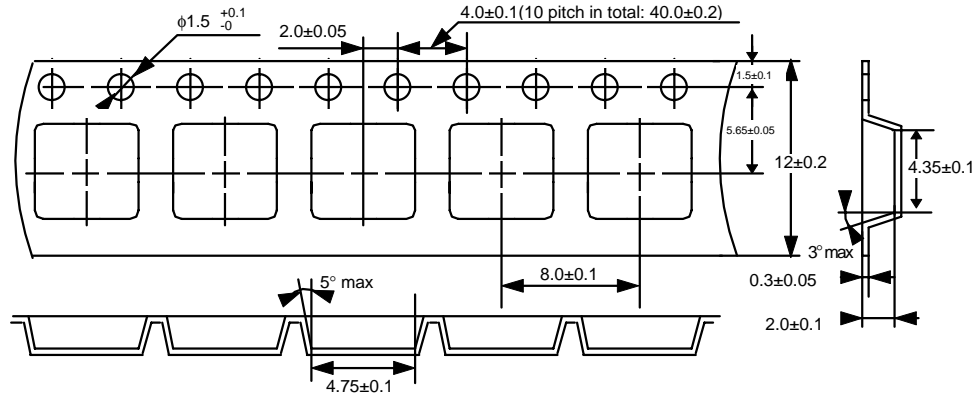

(2) Blue label

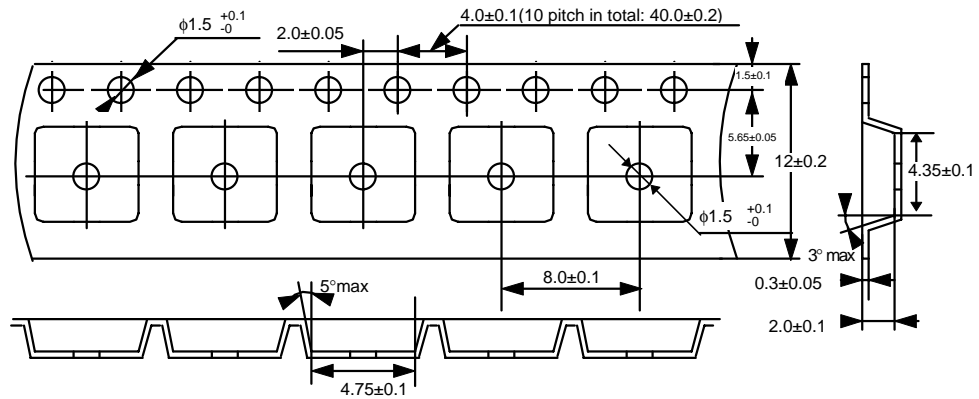

Unit: mm

T2 type

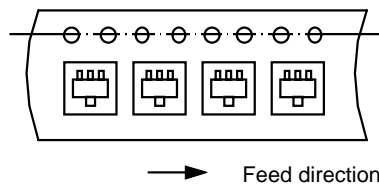
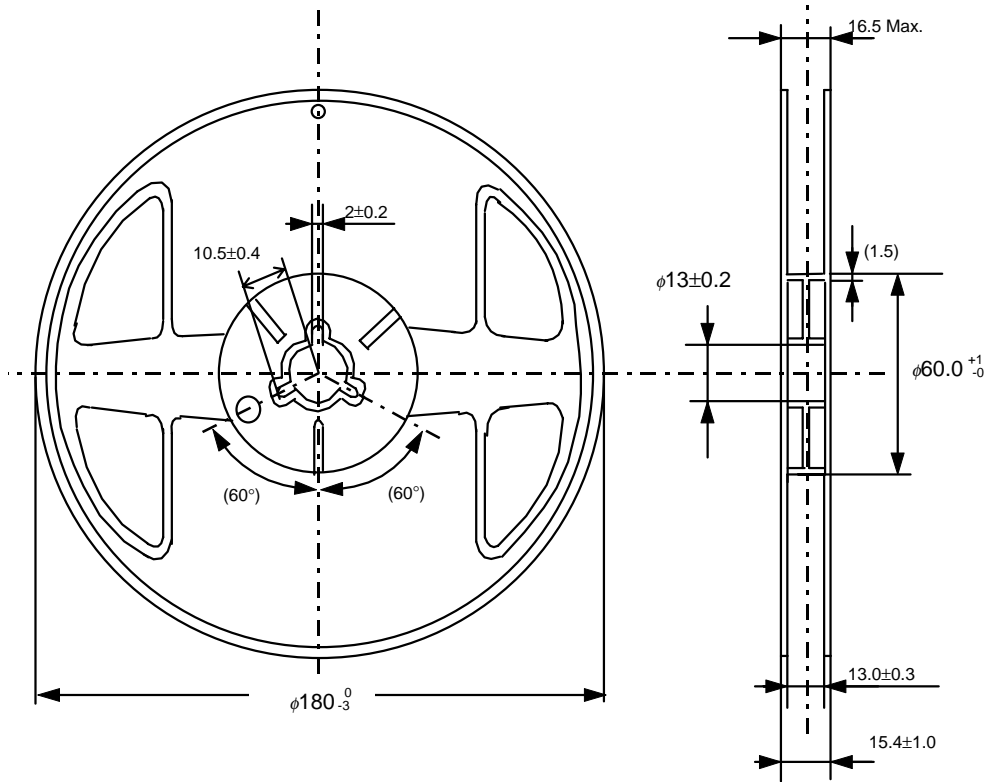

Figure 15

2.2 Reel specifications

1 reel holds 1000 detectors.



**Figure 16**

Unit: mm

3. SOT-23-5

3.1 Tape specifications

The emboss cover tape comes in two tones (milk white/transparent and transparent).

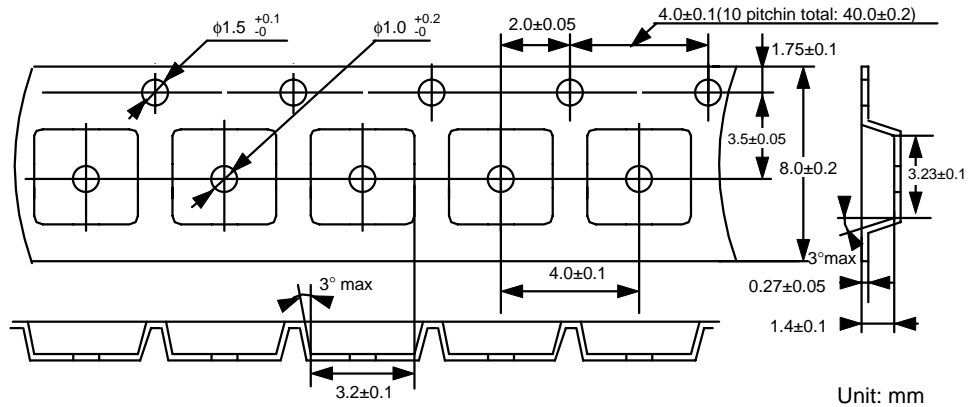

Unit: mm

T2 type

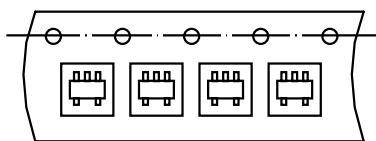

→ Feed direction

**Figure 17**

**SUPER-SMALL PACKAGE HIGH-PRECISION VOLTAGE DETECTOR**  
**S-808 Series**

3.2 Reel Specifications

1 reel holds 3000 detectors.

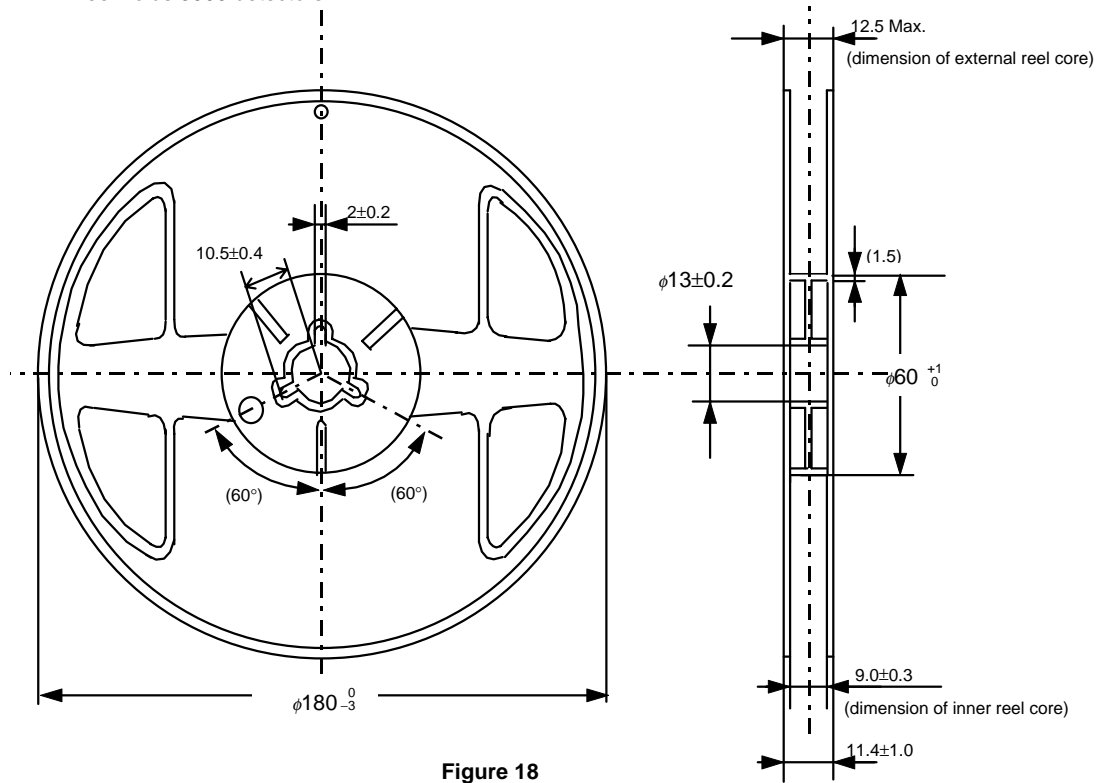
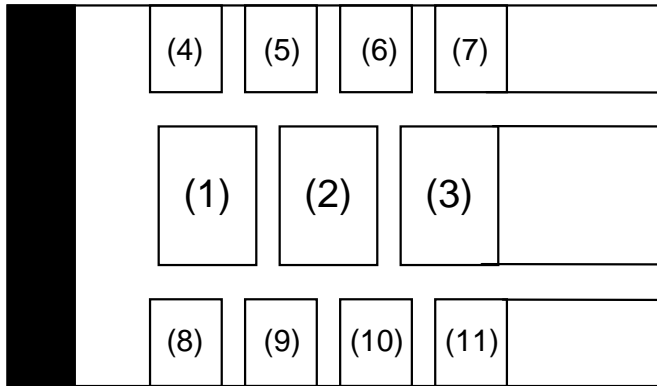

Figure 18

Unit: mm

■ Marking

1. SC-82AB



(1) to (3) Product name (abbreviation)  
 (4) to (11) Lot No. (indicated by dots)

2. TO-92

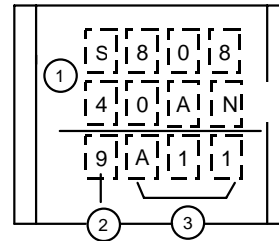

① Product name  
 ② Last digit of the year  
 ③ Lot No.

3. SOT-89-3

(1) White label

(2) Blue label

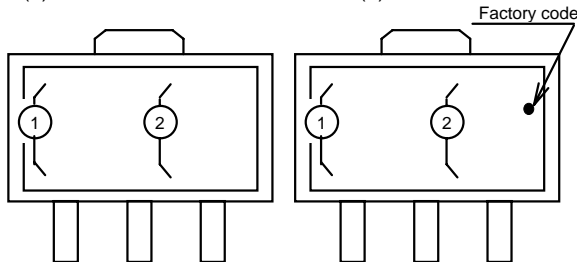

① Product name (abbreviation)  
 ② Lot No.

4. SOT-23-5

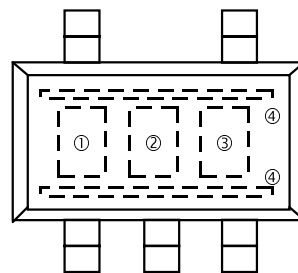

① and ② Product name (abbreviation)  
 ③ and ④ Lot No.  
 ③: Alphabet  
 ④: Dot on one side

Figure 19

**SUPER-SMALL PACKAGE HIGH-PRECISION VOLTAGE DETECTOR**  
**S-808 Series**

■ **Characteristics** (typical characteristics)

(1) Detection voltage ( $V_{DET}$ ) - Temperature ( $T_a$ )

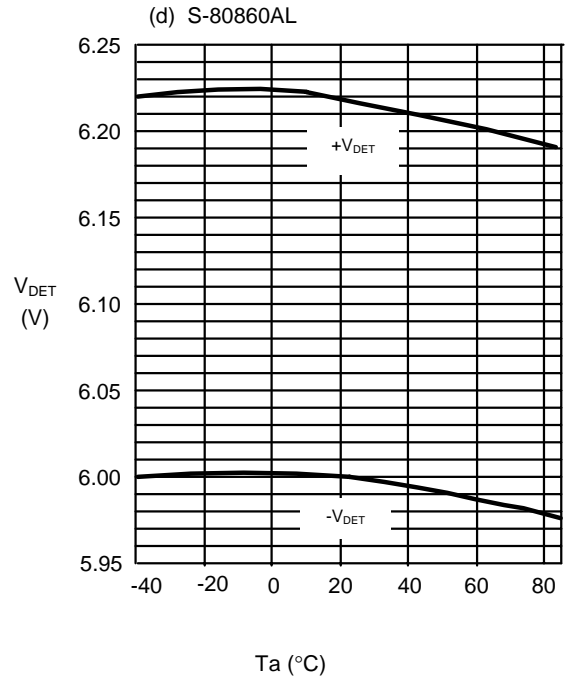
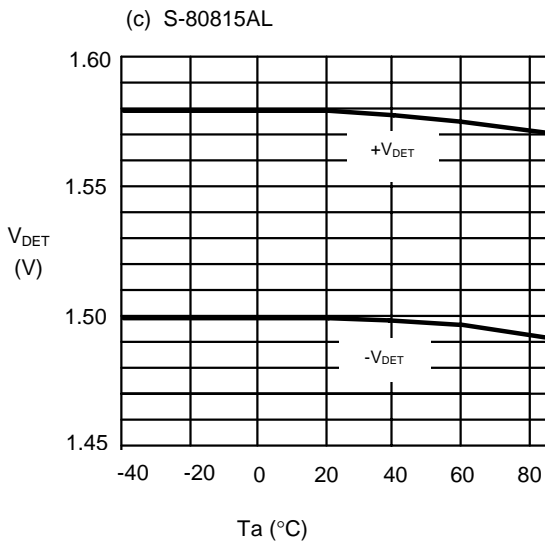
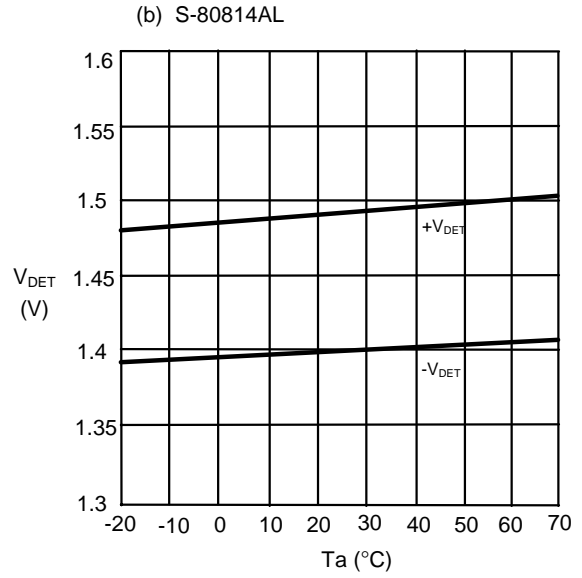
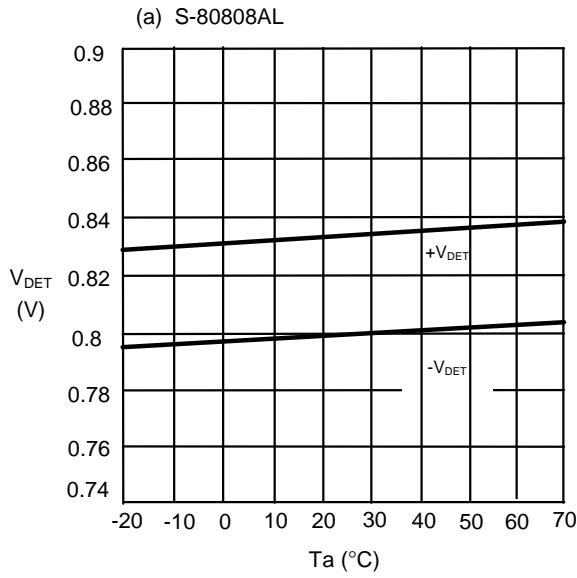

**SUPER-SMALL PACKAGE HIGH-PRECISION VOLTAGE DETECTOR**  
**S-808 Series**

(2) Hysteresis voltage width ( $V_{HYS}$ ) - Temperature ( $T_a$ )

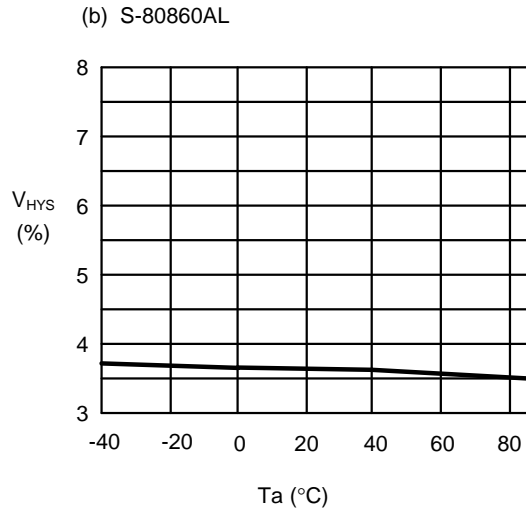
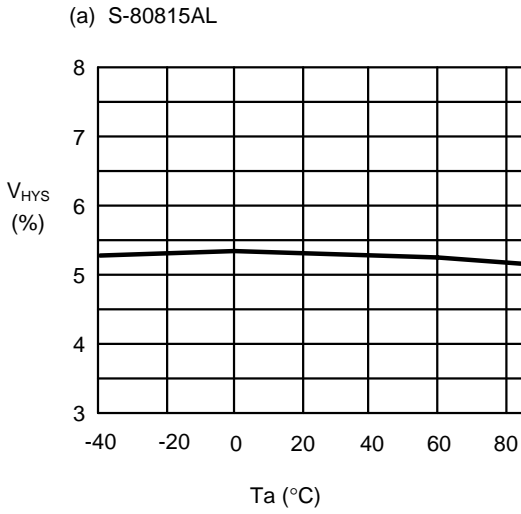

(3) Current consumption ( $I_{SS}$ ) - Input voltage ( $V_{DD}$ )

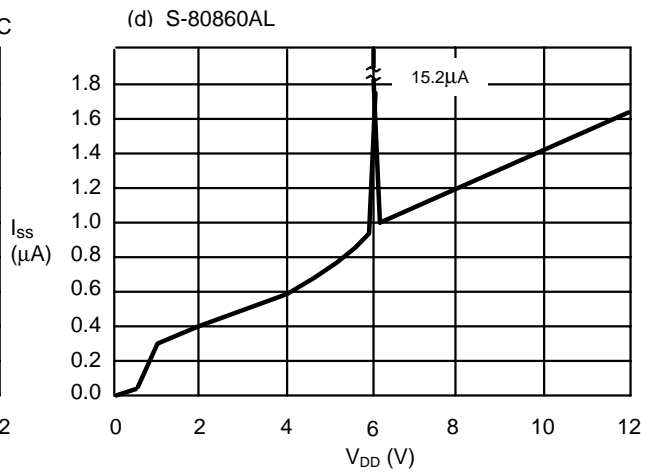
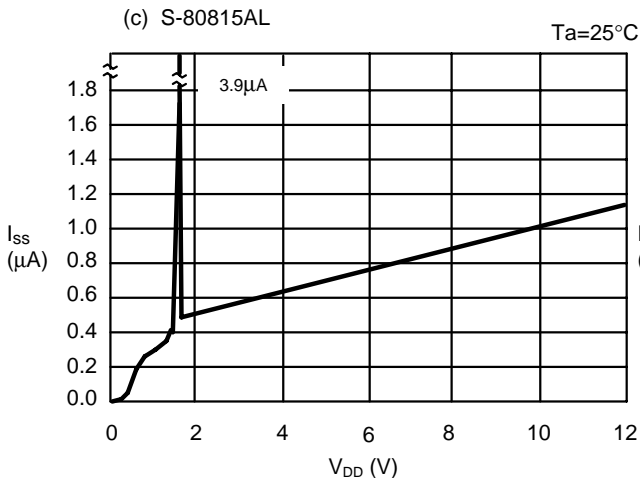
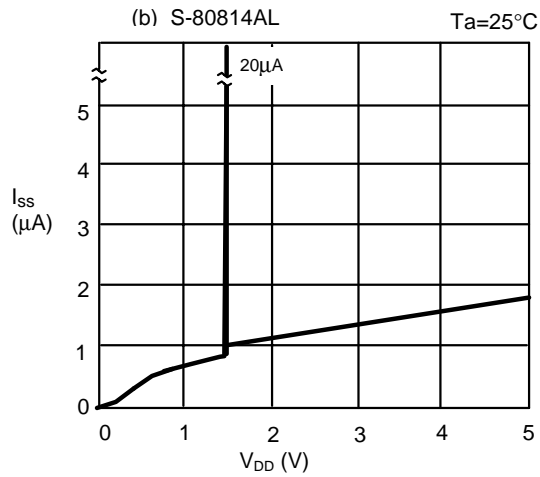
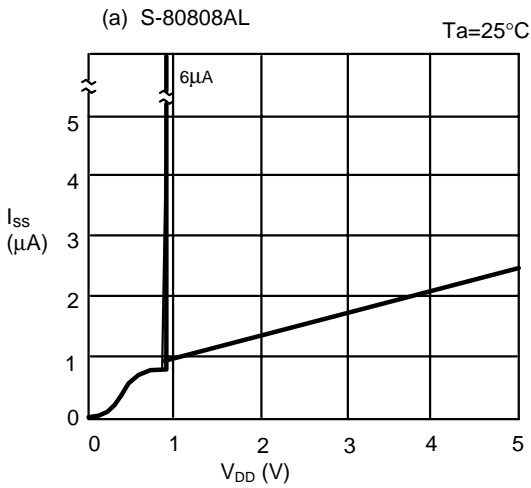

**SUPER-SMALL PACKAGE HIGH-PRECISION VOLTAGE DETECTOR**  
**S-808 Series**

(4) Current consumption ( $I_{SS}$ ) - Temperature ( $T_a$ )

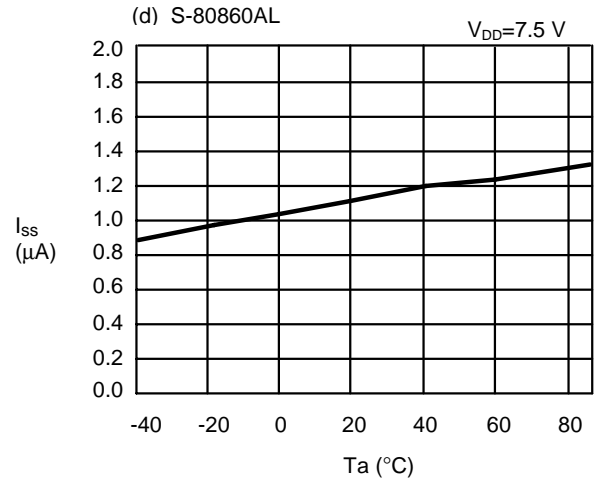
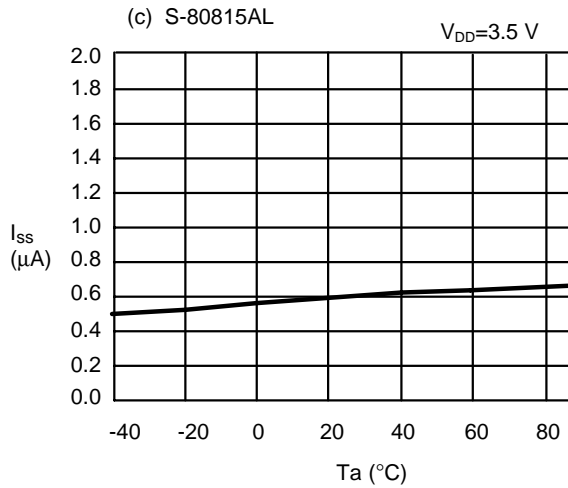
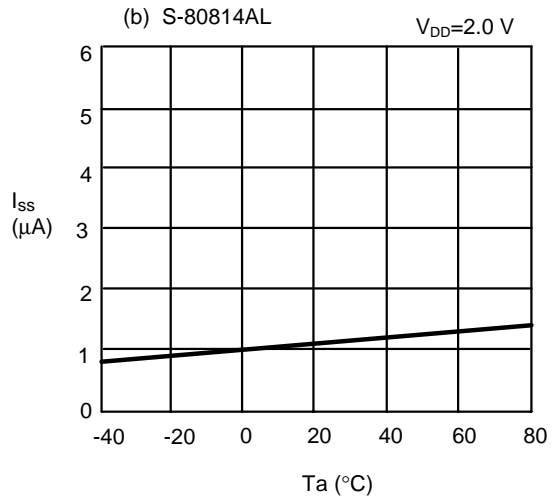
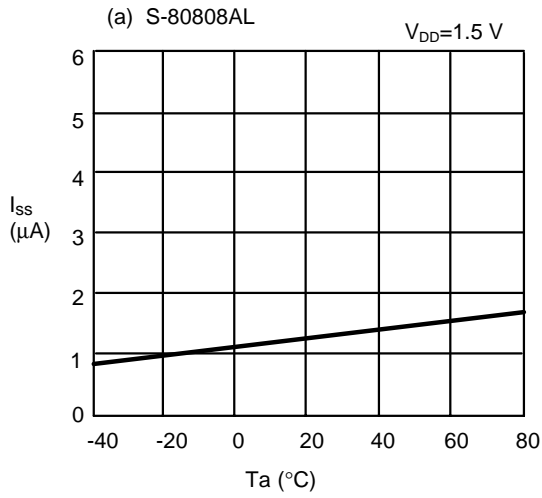



**SUPER-SMALL PACKAGE HIGH-PRECISION VOLTAGE DETECTOR**  
**S-808 Series**

(5) Nch transistor output current ( $I_{OUT}$ ) -  $V_{DS}$

(a) S-80814AL

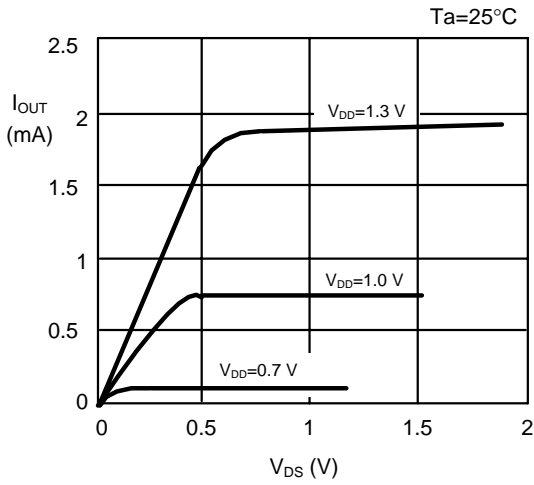

(b) S-80860AL

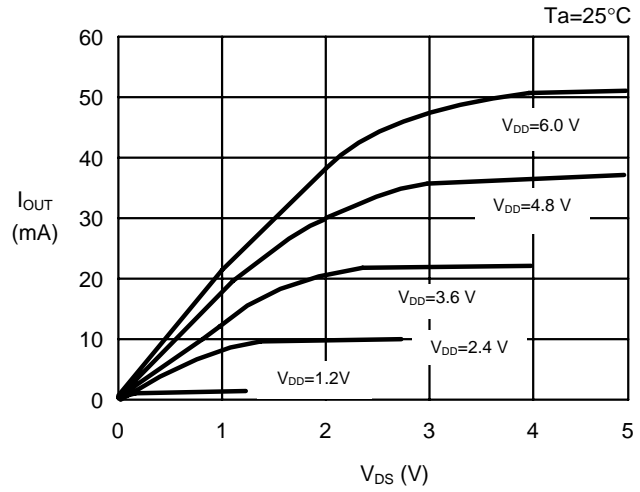

(6) Pch transistor output current ( $I_{OUT}$ ) -  $V_{DS}$

(a) S-80808AL

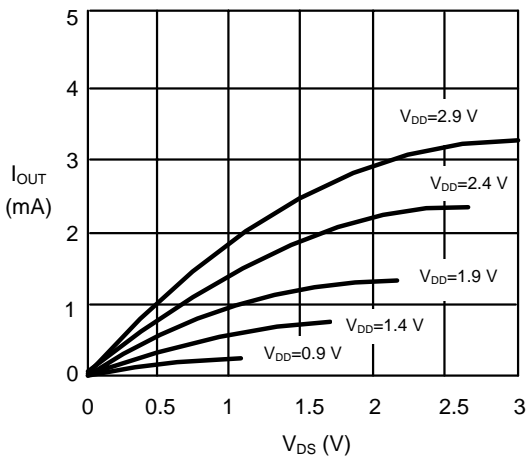

(b) S-80815AL

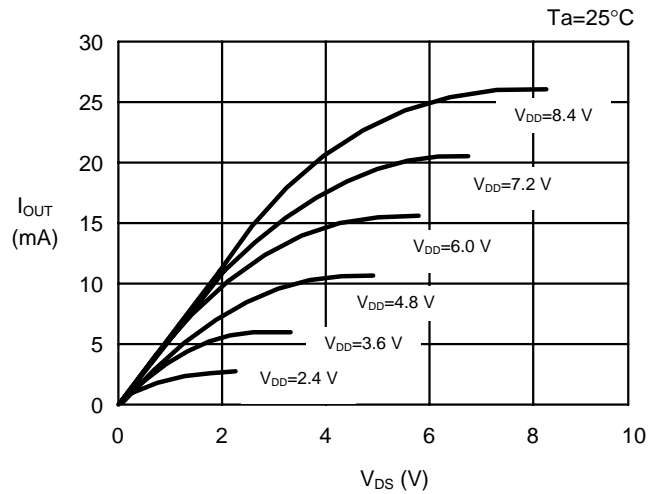

(7) Nch transistor output current ( $I_{OUT}$ ) - Input voltage ( $V_{DD}$ )

(a) S-80814AL

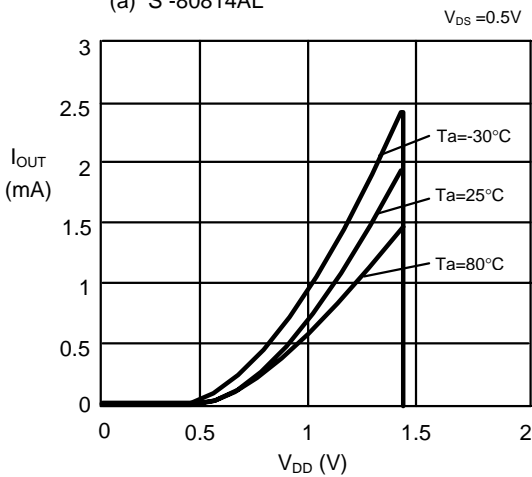

(b) S-80860AL

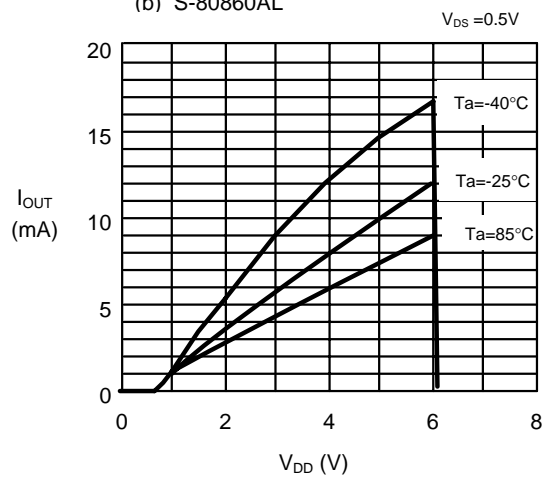

(8) Pch transistor output current( $I_{OUT}$ ) - Input voltage( $V_{DD}$ )

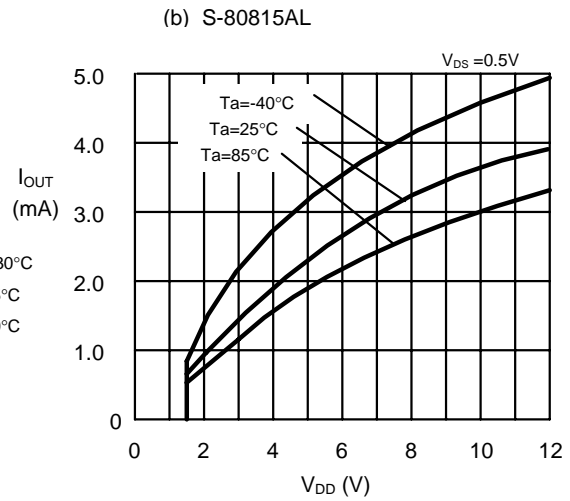
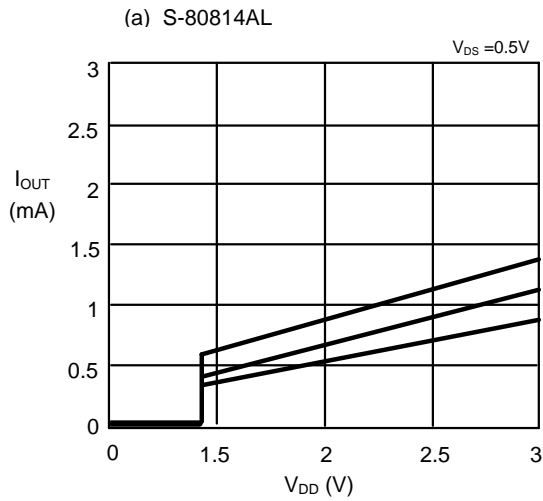

(9) Minimum operating voltage

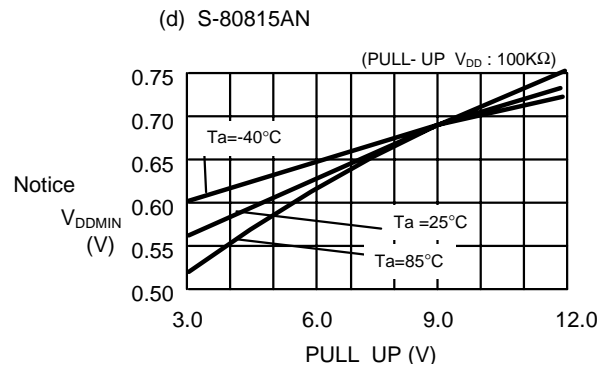
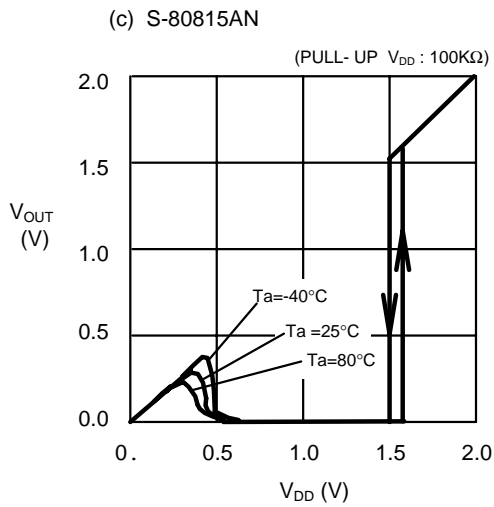
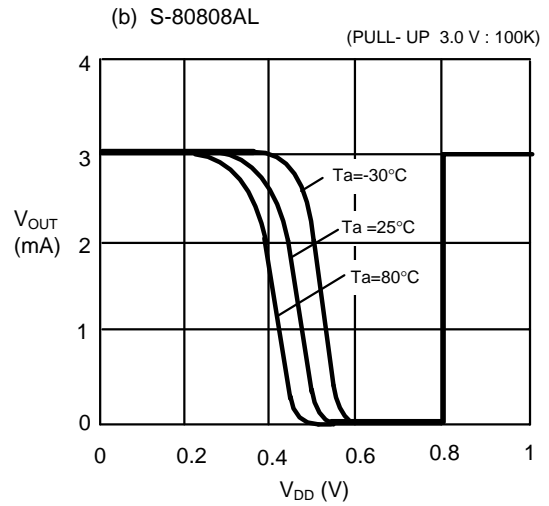
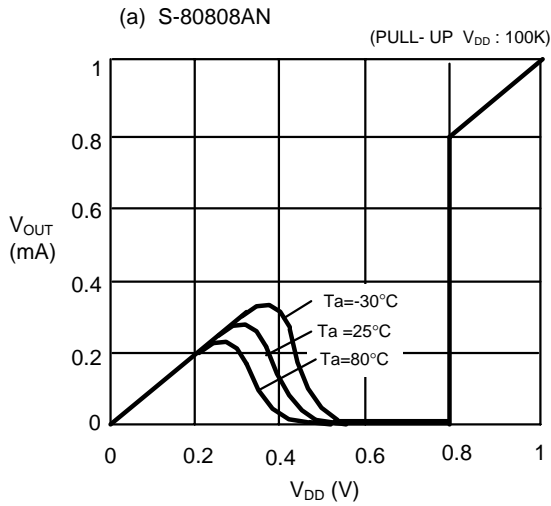

Remark:

$V_{DDMIN}$  is defined with  $V_{DD}$  when  $V_{OUT}$  goes below 10% of the PULL UP voltage as shown in Figure 20 when raising  $V_{DD}$  from 0 V.

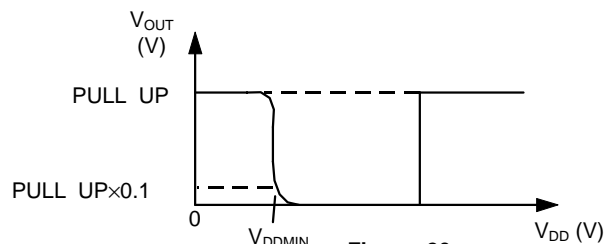
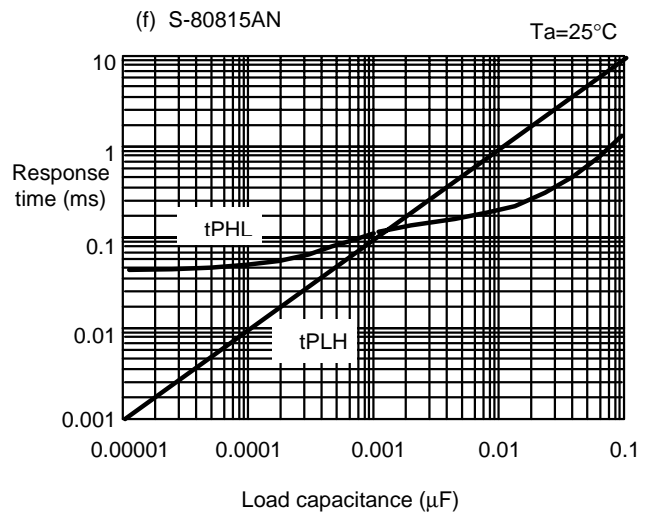
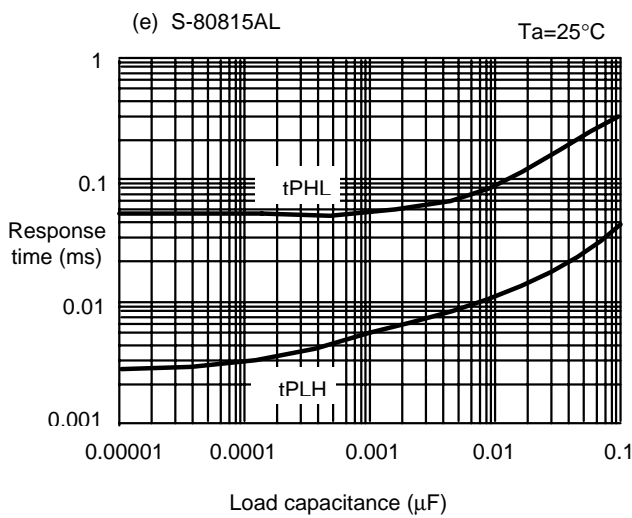
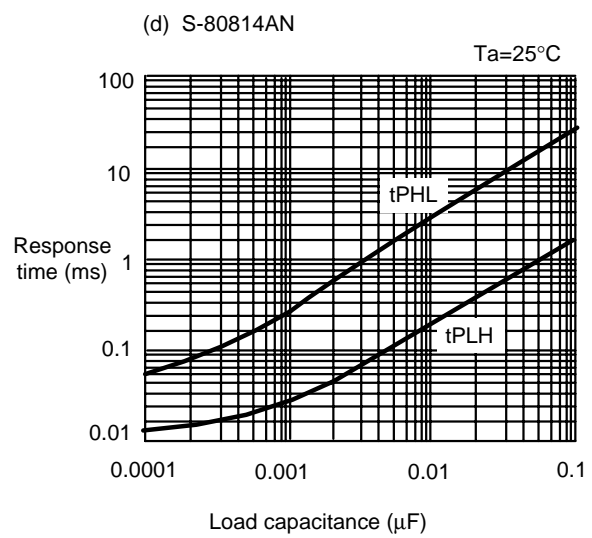
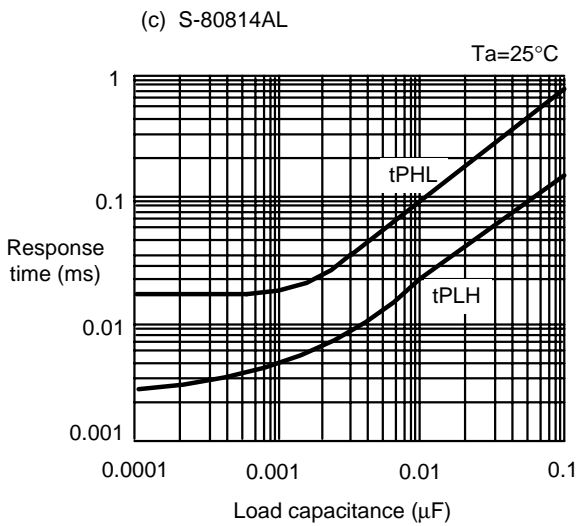
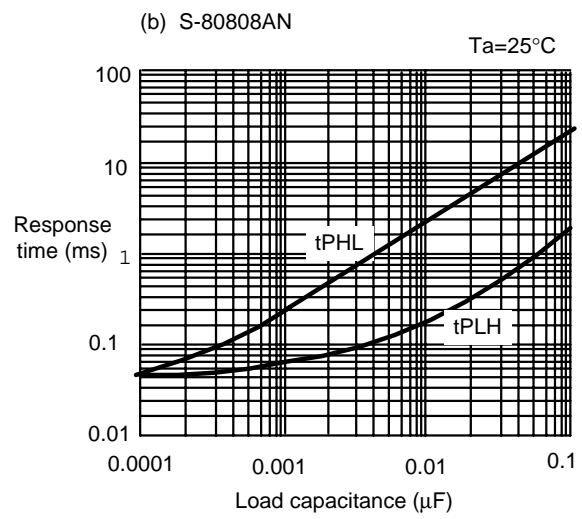
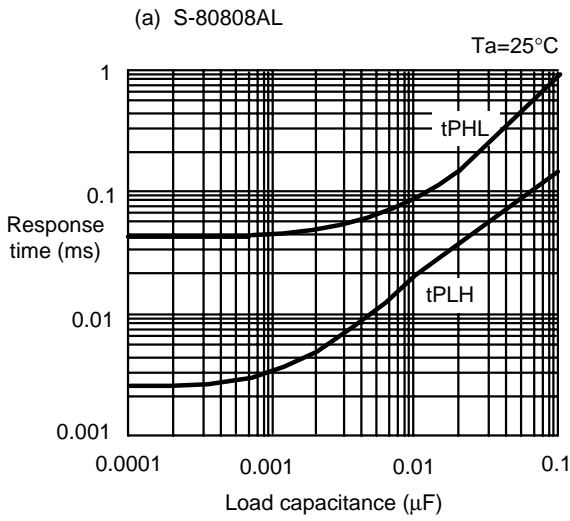

Figure 20

**SUPER-SMALL PACKAGE HIGH-PRECISION VOLTAGE DETECTOR**  
**S-808 Series**

(10) Dynamic response



**SUPER-SMALL PACKAGE HIGH-PRECISION VOLTAGE DETECTOR**  
**S-808 Series**

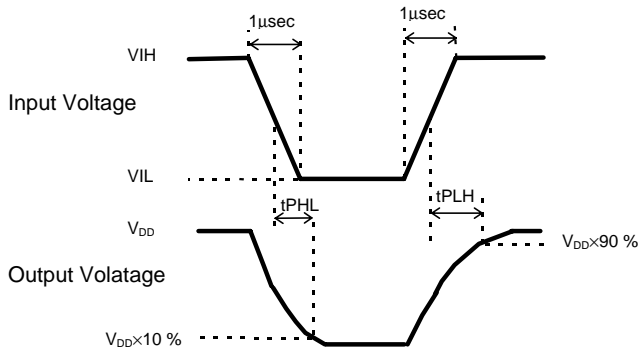
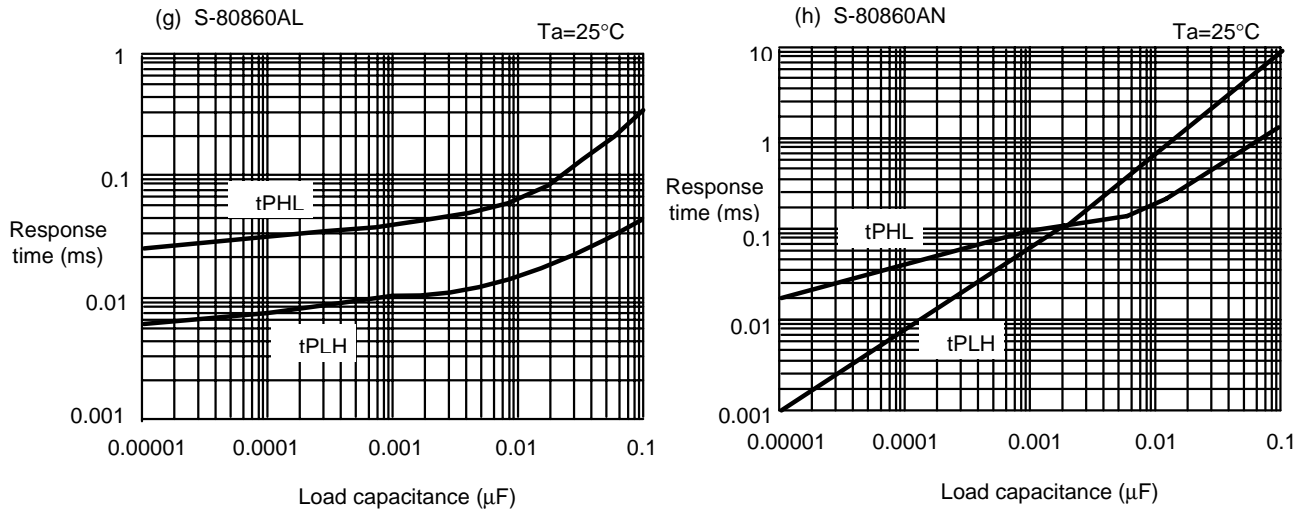

(a) - (d) :  $V_{IH}=5.0V, V_{IL}=0.7V$   
 (e) - (h) :  $V_{IH}=10V, V_{IL}=0.95V$

**Figure 21**

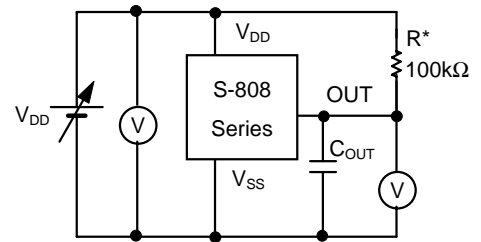

\* 'R' is not needed for CMOS output products.

**Figure 22**

# SUPER-SMALL PACKAGE HIGH-PRECISION VOLTAGE DETECTOR

## S-808 Series

### Application Circuit Examples

#### 1. Microcomputer reset circuits

If the power supply voltage to a microcomputer falls below the specified level, an unspecified operation may be performed or the contents of the memory register may be lost. When power supply voltage returns to normal, the microcomputer needs to be initialized before normal operations can be done.

Reset circuits protect microcomputers in the event of current being momentarily switched off or lowered. With the S-808 Series which has a low operating voltage, a high-precision detection voltage and hysteresis characteristic, the reset circuits shown in Figures 19 to 20 can be easily constructed.

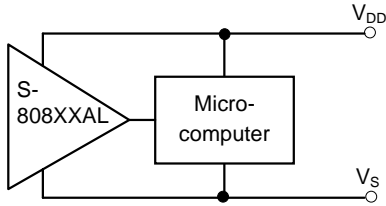
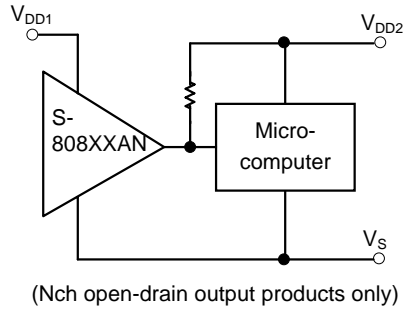

Figure 23



(Nch open-drain output products only)

Figure 24

#### 2. Addition of power-on reset circuit

A power-on reset circuit can be constructed using Nch open-drain product of S-808 Series.

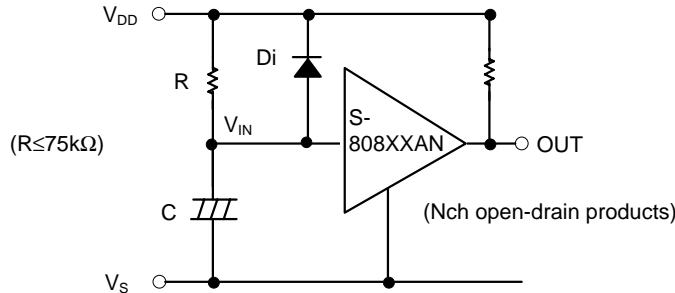

Note 1: R should be 75 kΩ or less for purpose of protection against oscillation.

Note 2: Di instantaneously discharges the electric charge stored by C at the falling of the power. Di is not necessary if delay in falling time is normal.



Figure 25

Note 3: When the power steeply rises, output may go high for a instant due to the IC inconstant region characteristics (output voltage is unstable in the region under minimum operating voltage) as shown in Figure. 26.



Figure 26

3. Change of detection voltage

In Nch open-drain output products of the S-808 Series, detection voltage can be changed using resistance dividers or diodes as shown in Figures 27 and 28. In Figure 27, hysteresis width is also changed.

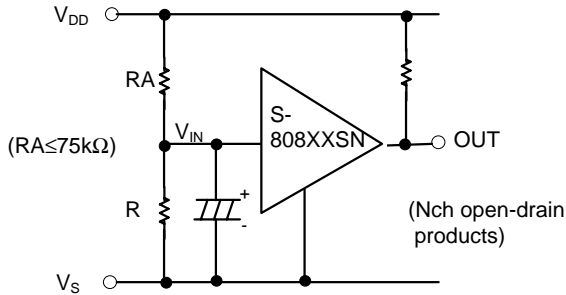

$$\text{Detection voltage} = \frac{RA+RB}{RB} \cdot -V_{DET}$$

$$\text{Hysteresis width} = \frac{RA+RB}{RB} \cdot V_{HYS}$$

Note1: If RA and RB are large, the hysteresis width may be larger than the value given by the formula above due to through-type current (which flows slightly in Nch open-drain circuit).

Note2: RA should be 75kΩ or less for purpose of protection against oscillation.

**Figure 27**

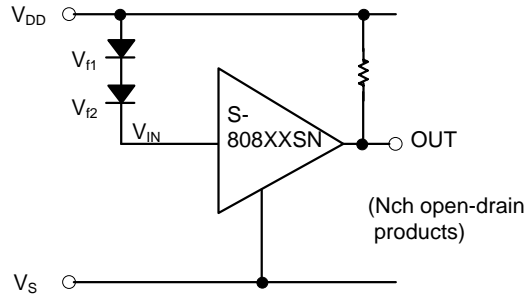

$$\text{Detection voltage} = V_{f1} + V_{f2} + (-V_{DET})$$

**Figure 28**

■ **Remarks**

- In CMOS output products of the S-808 Series, through-type current flows when the device is detecting or releasing. If a high impedance is connected to the input, oscillation may be caused due to the fall of the voltage by the through-type current when lowering the voltage during releasing.
- When designing for mass production using an application circuit described herein, take the product deviation and temperature characteristic into consideration.
- Seiko Instruments Inc. shall not bear any responsibility for the patents on the circuits described herein.

# Collection of Product FAQs

Author: Imura Yukihiro

Date : 99/05/27 (Thursday) 13:43 (Modified: 99/05/28 (Friday) 09:55)

## <Information level>

A: Public (Printing O.K.)

Index: A: General

## <Product>

Division name: 01 IC

Category 1: 11 Power Supply

Category 2: 1. Voltage Detectors

Cal No.: S-808

Related Documents:

## Question:

What is the table for S-8053/S-8054 series to S-808 series replacement?

## Answer:

Use the following table as a guide.

Type	Upper Line:S-805 Lower Line: S-808	Package	Detection Voltage (V)			Release Voltage (V)			Operation Voltage (V)			Point to be noted
			Min	Typ	Max	Min	Typ	Max	Min	Typ	Max	
S-8053ALB		TO-92	2.795	2.950	3.105	2.851	3.098	3.353	1.6	—	10.0	
S-80829ALY		TO-92	2.842	2.900	2.958	2.927	3.045	3.195	0.95	—	10.0	

S-8053ALB-LI		SOT-89-3	2.795	2.950	3.105	2.851	3.098	3.353	1.6	—	10.0	
S-80829ALUP-EAS		SOT-89-3	2.842	2.900	2.958	2.927	3.045	3.195	0.95	—	10.0	

S-8053HLB		TO-92	2.895	3.000	3.105	2.953	3.150	3.353	1.6	—	10.0	
S-80830ALY		TO-92	2.940	3.000	3.060	3.028	3.150	3.305	0.95	—	10.0	

S-8053HNB		TO-92	2.895	3.000	3.105	2.953	3.150	3.353	1.6	—	10.0	
S-80830ANY		TO-92	2.940	3.000	3.060	3.028	3.150	3.305	0.95	—	10.0	

S-8053ALR		TO-92	3.095	3.250	3.405	3.157	3.413	3.677	1.6	—	10.0	
S-80832ALY		TO-92	3.136	3.200	3.264	3.230	3.360	3.525	0.95	—	10.0	

S-8053ALR-LJ	SOT-89-3	3.095	3.250	3.405	3.157	3.413	3.677	1.6	—	10.0	
S-80832ALUP-EAW	SOT-89-3	3.136	3.200	3.264	3.230	3.360	3.525	0.95	—	10.0	

S-8053ANO	TO-92	3.395	3.550	3.705	3.463	3.728	4.001	1.6	—	10.0	
S-80835ANY	TO-92	3.430	3.500	3.570	3.533	3.675	3.856	0.95	—	10.0	

S-8054ALB	TO-92	3.995	4.150	4.305	4.075	4.358	4.649	1.6	—	10.0	
S-80841ALY	TO-92	4.018	4.100	4.182	4.139	4.305	4.517	0.95	—	10.0	

S-8054ALB-LM	SOT-89-3	3.995	4.150	4.305	4.075	4.358	4.649	1.6	—	10.0	
S-80841ALUP-EA5	SOT-89-3	4.018	4.100	4.182	4.139	4.305	4.517	0.95	—	10.0	

S-8054ALR	TO-92	4.295	4.450	4.605	4.381	4.673	4.973	1.6	—	10.0	
S-80844ALY	TO-92	4.312	4.400	4.488	4.441	4.620	4.847	0.95	—	10.0	

S-8054ALR-LN	SOT-89-3	4.295	4.450	4.605	4.381	4.673	4.973	1.6	—	10.0	
S-80844ALUP-EA8	SOT-89-3	4.312	4.400	4.488	4.441	4.620	4.847	0.95	—	10.0	

S-8054ALO	TO-92	4.595	4.750	4.905	4.687	4.988	5.297	1.6	—	10.0	
S-80847ALY	TO-92	4.606	4.700	4.794	4.744	4.935	5.178	0.95	—	10.0	

S-8054ALO-LO	SOT-89-3	4.595	4.750	4.905	4.687	4.988	5.297	1.6	—	10.0	
S-80847ALUP-EEB	SOT-89-3	4.606	4.700	4.794	4.744	4.935	5.178	0.95	—	10.0	

S-8054ALY	TO-92	4.895	5.100	5.205	4.993	5.355	5.621	1.6	—	10.0	
S-80851ALY	TO-92	4.998	5.100	5.202	5.148	5.355	5.618	0.95	—	10.0	

S-8054ALY-LP	SOT-89-3	4.895	5.100	5.205	4.993	5.355	5.621	1.6	—	10.0	
S-80851ALUP-EEF	SOT-89-3	4.998	5.100	5.202	5.148	5.355	5.618	0.95	—	10.0	

S-8054HN	TO-92	3.800	4.000	4.200	3.876	4.200	4.536	1.6	—	10.0	
S-80839ANY	TO-92	3.822	3.900	3.978	3.937	4.095	4.296	0.95	—	10.0	

S-8054HN-CB	SOT-89-3	3.800	4.000	4.200	3.876	4.200	4.536	1.6	—	10.0	
S-80839ANUP-ED3	SOT-89-3	3.822	3.900	3.978	3.937	4.095	4.296	0.95	—	10.0	



S-8054HNM	TO-92	4.500	4.600	4.700	—	4.650	4.800	1.6	—	10.0	
S-80846ANY	TO-92	4.508	4.600	4.692	4.643	4.830	5.067	0.95	—	10.0	Max. value of release voltage
S-80845ANY	TO-92	4.410	4.500	4.590	4.542	4.725	4.957	0.95	—	10.0	Max. value of release voltage
S-80844ANY	TO-92	4.312	4.400	4.488	4.441	4.620	4.847	0.95	—	10.0	Min. value of detection voltage
S-8054HNM-CQ	SOT-89-3	4.500	4.600	4.700	—	4.650	4.800	1.6	—	10.0	
S-80846ANUP-EJA	SOT-89-3	4.508	4.600	4.692	4.643	4.830	5.067	0.95	—	10.0	Max. value of release voltage
S-80845ANUP-ED9	SOT-89-3	4.410	4.500	4.590	4.542	4.725	4.957	0.95	—	10.0	Max. value of release voltage
S-80844ANUP-ED8	SOT-89-3	4.312	4.400	4.488	4.441	4.620	4.847	0.95	—	10.0	Min. value of detection voltage

The production of the S8054HNM will be continued, but this product cannot be newly employed.

<Remarks>

FAQ No.: 11S808002

# Collection of Product FAQs

Author: Imura Yukihiro

Date: 99/05/27 (Thursday) 13:12 (Modified: 99/05/27 (Thursday) 13:37)

## <Information level>

A: Public (Printing O.K.)

Index: A: General

## <Product>

Division name: 01 IC

Category 1: 11 Power Supply

Category 2: 1. Voltage Detectors

Cal No.: S-808

Related Documents:

## Question:

What is the table for S-8051/S-8052 series to S-808 series replacement?

## Answer:

Use the following table as a guide.

Type	Upper Line: S-805 Lower Line: S-808	Package	Detection Voltage (V)			Release Voltage (V)			Operation Voltage (V)			Point to be noted
			Min	Typ	Max	Min	Typ	Max	Min	Typ	Max	
S-8051ANB		TO-92	0.995	1.050	1.105	1.015	1.103	1.193	0.9	—	5.0	
S-80810ANNP-E70		SC-82AB	0.980	1.000	1.020	1.017	1.054	1.091	0.7	—	5.0	Difference in package

S-8051ANB-NA		SOT-89-3	0.995	1.050	1.105	1.015	1.103	1.193	0.9	—	5.0	
S-80810ANNP-E70		SC-82AB	0.980	1.000	1.020	1.017	1.054	1.091	0.7	—	5.0	Difference in package

S-8051ANR		TO-92	1.095	1.150	1.205	1.117	1.208	1.301	1.0	—	5.0	
S-80811ANNP-E71		SC-82AB	1.078	1.100	1.122	1.125	1.164	1.203	0.7	—	5.0	Difference in package

S-8051ANR-NB		SOT-89-3	1.095	1.150	1.205	1.117	1.208	1.301	1.0	—	5.0	
S-80811ANNP-E71		SC-82AB	1.078	1.100	1.122	1.125	1.164	1.203	0.7	—	5.0	Difference in package

S-8051HN-CD		SOT-89-3	1.795	1.900	2.005	1.831	1.995	2.165	1.5	—	10.0	
S-80819ANUP-EDG		SOT-89-3	1.862	1.900	1.938	1.918	1.995	2.093	0.95	—	10.0	

S-8052ANB-NE	SOT-89-3	1.995	2.100	2.205	2.035	2.205	2.381	1.5	—	10.0	
S-80821ANUP-EDJ	SOT-89-3	2.058	2.100	2.142	2.120	2.205	2.313	0.95	—	10.0	

S-8052ALB	TO-92	1.995	2.100	2.205	2.035	2.205	2.381	1.5	—	10.0	
S-80821ALY	TO-92	2.058	2.100	2.142	2.120	2.205	2.313	0.95	—	10.0	

S-8052ALB-LE	SOT-89-3	1.995	2.100	2.205	2.035	2.205	2.381	1.5	—	10.0	
S-80821ALUP-EAJ	SOT-89-3	2.058	2.100	2.142	2.120	2.205	2.313	0.95	—	10.0	

S-8052ALR	TO-92	2.195	2.300	2.405	2.239	2.415	2.597	1.5	—	10.0	
S-80823ALY	TO-92	2.254	2.300	2.346	2.322	2.415	2.534	0.95	—	10.0	

S-8052ALR-LF	SOT-89-3	2.195	2.300	2.405	2.239	2.415	2.597	1.5	—	10.0	
S-80823ALUP-EAL	SOT-89-3	2.254	2.300	2.346	2.322	2.415	2.534	0.95	—	10.0	

S-8052ALO	TO-92	2.395	2.500	2.605	2.443	2.625	2.813	1.5	—	10.0	
S-80825ALY	TO-92	2.450	2.500	2.550	2.524	2.625	2.754	0.95	—	10.0	

S-8052ALO-LG	SOT-89-3	2.395	2.500	2.605	2.443	2.625	2.813	1.5	—	10.0	
S-80825ALUP-EAN	SOT-89-3	2.450	2.500	2.550	2.524	2.625	2.754	0.95	—	10.0	

S-8052ALY	TO-92	2.595	2.700	2.805	2.647	2.835	3.029	1.5	—	10.0	
S-80827ALY	TO-92	2.646	2.700	2.754	2.725	2.835	2.974	0.95	—	10.0	

S-8052ALY-LH	SOT-89-3	2.595	2.700	2.805	2.647	2.835	3.029	1.5	—	10.0	
S-80827ALUP-EAQ	SOT-89-3	2.646	2.700	2.754	2.725	2.835	2.974	0.95	—	10.0	

S-8052ANY-NH	SOT-89-3	2.595	2.700	2.805	2.647	2.835	3.029	1.5	—	10.0	
S-80827ANUP-EDQ	SOT-89-3	2.646	2.700	2.754	2.725	2.835	2.974	0.95	—	10.0	

S-8052HNM	TO-92	2.295	2.400	2.505	4.300	4.400	4.500	1.5	—	10.0	
S-80824ANY	TO-92	2.352	2.400	2.448	2.423	2.520	2.644	0.95	—	10.0	Release voltage

S-8052HNM-CR	SOT-89-3	2.295	2.400	2.505	4.300	4.400	4.500	1.5	—	10.0	
S-80824ANUP-EDM	SOT-89-3	2.352	2.400	2.448	2.423	2.520	2.644	0.95	—	10.0	Release voltage

The production of the S8052HNM will be continued, but this product cannot be newly employed.

<Remarks>

FAQ No.: 11S808001